

# Certifier™ Pro Flow Analyzer



Model 4090

Quick Start Guide

P/N 6016201, Revision C  
May 2023



# Certifier™ Pro Instrument Components







## Certifier™ Pro Test Kit (Model 4090)

Material Description	Replacement Part
Power supply 100/240 VAC to +12 VDC 2.1 mm, includes plug set with NA, UK, EU, CN, SAA	130400
Inlet filter, high flow, 22 mm M/F, HEPA	1602341
Inlet filter, low flow, 3/8 inch barb, HEPA	130380
Adapter, high pressure port	1611221
Adapter, 22 mm to 6 mm (for interfacing the Low Flow Filter to the High Flow channel)	1102091
Adapter, 15 mm ID to 22 mm OD	1102093
Adapter, 22 mm F to 22 mm F, Straight	130373
Adapter, 15 mm M to 22 mm F, Pediatric Cuff	130374
Airway pressure fitting with screen	1611330
Pressure tubing, silicone, 1/8 inch ID x 1/4 inch OD x 48 inch	3002053
Oxygen Sensor (installed)	130377
Battery, Lithium-Ion 7.2 V 6.4 Ahr (installed)	130385
Hanging Clip (to hang 4090 from a ventilator rail)	130375

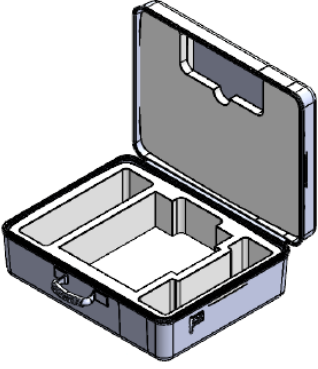

[Download Operator's Manual at TSI.com](https://www.tsi.com)

## Certifier™ Pro Accessories

Description	Part Number	Image
Carrying Case, Fitted (19 x 14.75 x 6.5 inch 48 x 37.5 x 16.5 cm)	130378	
Test Lung, Adult, 1 L	130393	
Test Lung, Pediatric, 0.5 L	130396	
Computer Cable, USB- C to USB-A, with Screw Lock	130382	
Stylus, Capacitive Touch	130370	
Flow Resistor Kit, Calibrated Resistors (Rp5, Rp20, Rp50)	130395	

# Instrument Overviews

## 4090 Instrument, Front



1. Low Flow Channel Inlet	4. Low Differential Pressure, Positive Port (+)
2. High Flow Channel Inlet	5. Low Differential Pressure, Negative Port (-)
3. High Pressure Port (Max: 150 psi / 10 bar)	6. Touchscreen Display

## 4090 Instrument, Back



1. Low Flow Channel Outlet	7. USB-C Communications Output
2. High Flow Channel Outlet	8. Screw hole for USB-C cable lock
3. Power Button (On/Off)	9. USB-A Connectors (2)
4. RS-232 Output	10. Portable / Rack Switch
5. TTL Trigger Input	11. Cable Retainer
6. DC Power Input	12. Model / Serial Number Sticker

## 4090 Instrument, Bottom



1. Battery/Oxygen Sensor Cover	4. Rubber Feet
2. Cover Knob	5. Fan
3. Instrument Handle	6. Cable Retainer

## Available Measurement Parameters

Symbol	Description	Symbol	Description
$\dot{V}$	Flow rate	P <sub>PLAT</sub>	Plateau pressure
$\dot{V}_{PEAK}$	Peak flow rate	P <sub>HIGH</sub>	High pressure (4081 only)
V <sub>MIN</sub>	Minimum flow rate	P <sub>ABS</sub>	Absolute pressure, equals barometric pressure if flow tube open to atmosphere.
$\dot{V}_{\Delta}$	Flow rate delta	O <sub>2</sub>	Oxygen concentration (4081 with 4073 only)
$\dot{V}_{\Delta\%}$	Flow rate delta percent	T	Temperature
V <sub>TI</sub>	Inhaled tidal volume	f	Breath frequency
V <sub>TE</sub>	Exhaled tidal volume	t <sub>I</sub>	Inspiratory time
V	Real-time volume	t <sub>IP</sub>	Inspiratory pause time
MV	Inhaled minute tidal volume	t <sub>I+P</sub>	Inspiratory time including pause time
P	Low pressure measurement (4081 only)	t <sub>R</sub>	Inspiratory rise time
PIP	Peak inspiratory pressure (4081 only)	t <sub>E</sub>	Expiratory time
P <sub>EEP</sub>	Peak end expiratory pressure (4081 only)	I:E	Inspiratory to Expiratory ratio
P <sub>MAP</sub>	Mean airway pressure (4081 only)	I:E <sub>IP</sub>	Inspiratory to Expiratory ratio including pause time
P <sub>MIN</sub>	Minimum low pressure (4081 only)	C <sub>STAT</sub>	Static compliance
P <sub>Δ</sub>	Delta low pressure – Delta airway pressure (4081 only)	🕒	Time of day

# Measurement Parameter Definitions

Refer to the Certifier™ Pro User Manual for more detailed definitions of the measurement parameters.

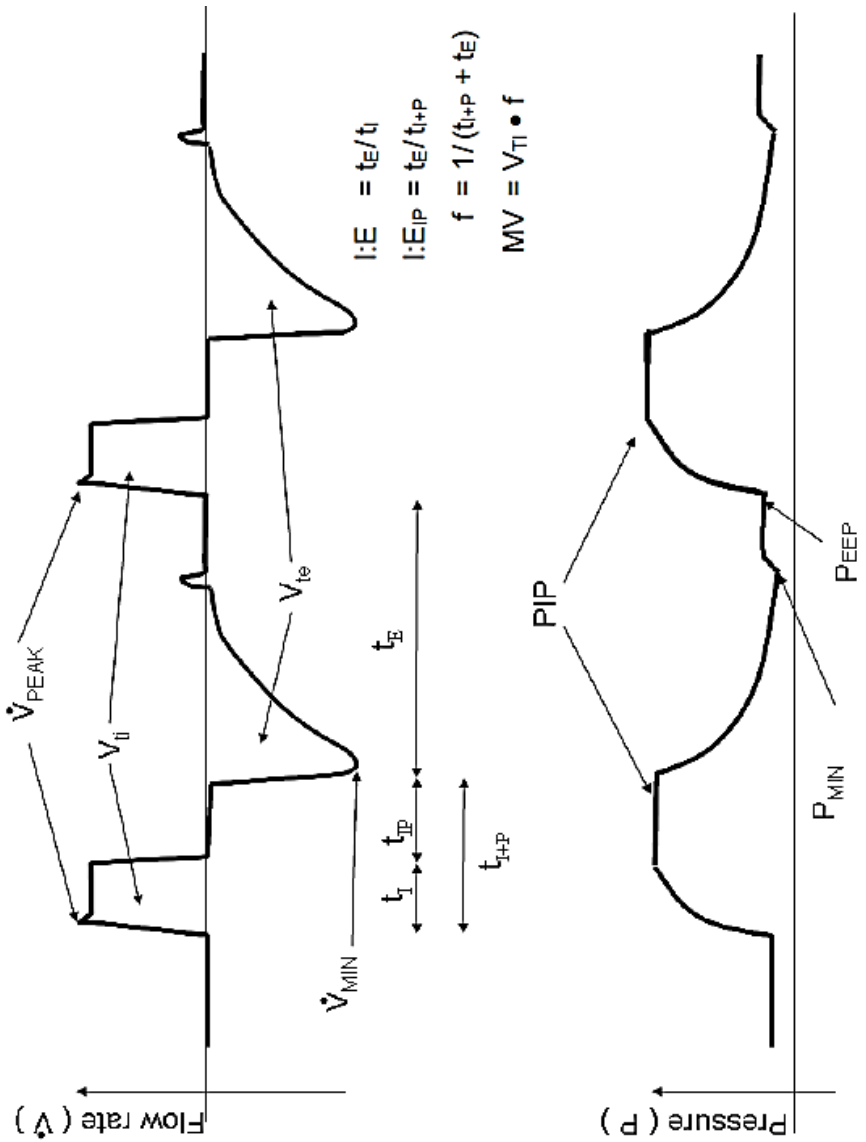

---

---

## Pre-Test Checks and Instrument Setup

### Power and Warmup

The Certifier™ Pro Flow Analyzer can be operated through AC power or on battery power. With AC power applied, the battery will automatically recharge. Upon startup, allow 1 minute for the Certifier™ Flow Analyzer's flow sensor and pressure transducers to warm up.

### Instrument Calibration

Confirm that the calibration date for the Certifier™ Pro Flow Analyzer is valid. TSI® recommends an annual calibration to ensure the most accurate flow, pressure, and temperature measurements.

### Zero Low / High Pressure

Disconnect any pressure tubing from the low and high pressure ports on the front side of the instrument to expose the sensors to ambient air. Press the zero icon on the Certifier Pro display to access the Zero Pressure Sensors screen and perform the zeroing.

### Oxygen Sensor Calibration

Calibrate the oxygen sensor daily, following an altitude change, or after replacement. Navigate to the Settings menu and select **Oxygen Sensor**. Follow the directions on screen to calibrate with air or oxygen.

### Connect Inlet Filter

Connect filter to the breathing circuit upstream of the Certifier Flow Analyzer. TSI® supplies inlet filters for the high and low flow channels and recommends that filtration be used at all times during operation.

### Connect Low Pressure Measurement

Attach the airway pressure fitting (1) to the breathing circuit. Cut a length of silicon tubing (2), connect one end of the tubing to the barb on the airway pressure fitting, and connect the other end of the tubing to the (+) low pressure port located at the front of the instrument.



## Test Circuit for Bi-directional Flow

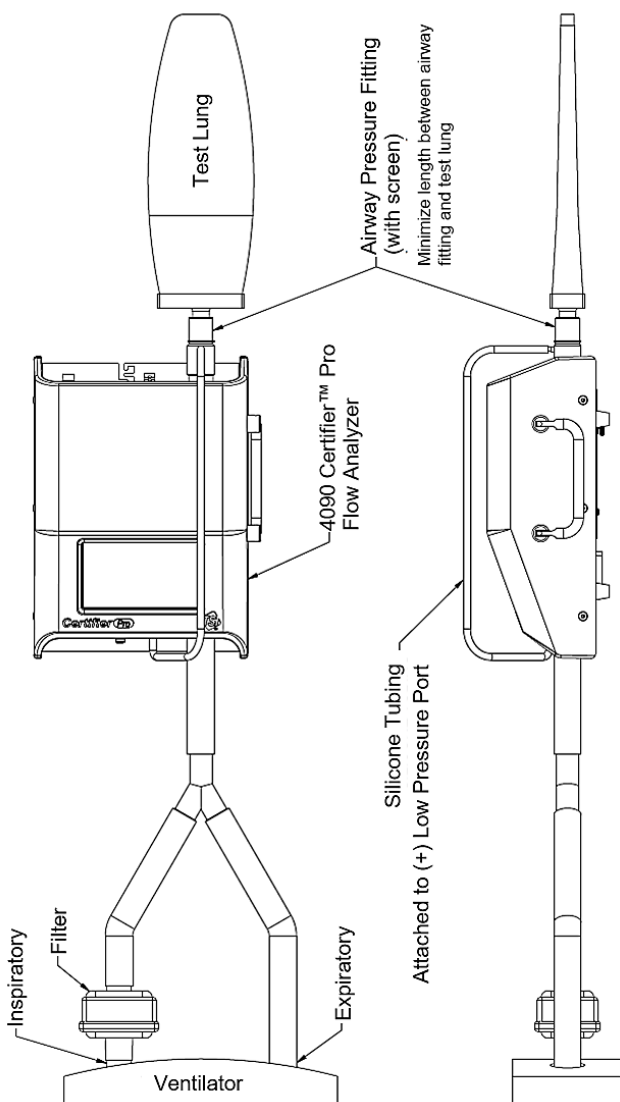

---

## Touchscreen Operation

The Certifier™ Pro instrument utilizes a 5-inch capacitive™ touchscreen display. The display interface is designed to be operated using your fingers, press lightly on the display for optimum touchscreen operation. A capacitive-touch stylus can be used as an alternative to operating with finger presses.

Operate the Certifier™ Pro Flow Analyzer by touching any on-screen element that you would like to change. Up to 18 measurement parameters can be displayed on screen at one time, and the display will automatically adjust the font size and positioning based on the number of selected measurements.

### Parameter Screen

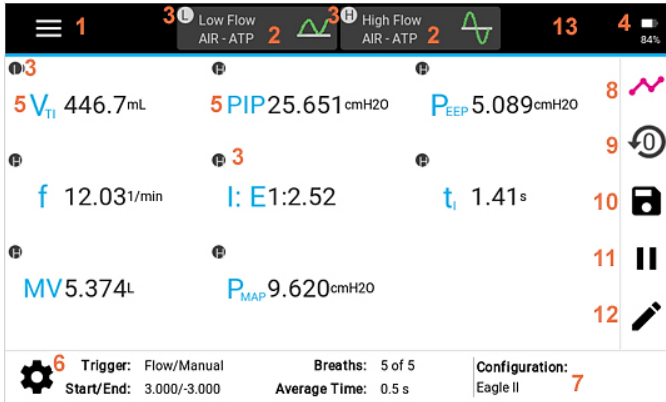

1. Menu	8. Parameter/Graph Screen Toggle
2. Module Cards	9. Zero Pressure Sensors
3. Module Indicators	10. Save Data and/or Snapshots
4. Battery Indicator	11. Pause/Play Display
5. Measurement and Units	12. Edit Measurements and/or Units
6. Triggers / Averaging Settings	13. Warnings & Errors Notifications
7. User Configurations	

### Graph Screen

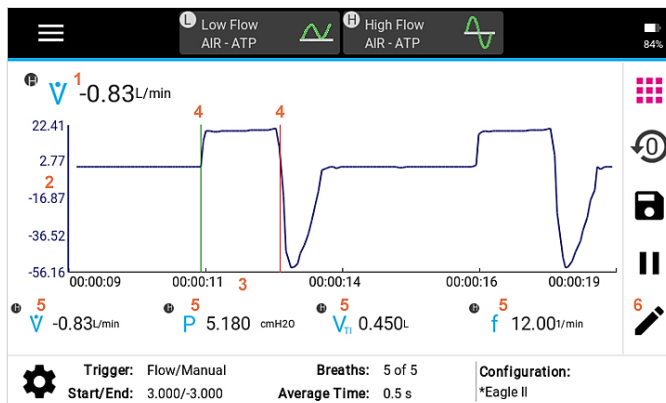

1. Plotted Measurements	4. Breath Trigger Indicators
2. Y-Axis (primary and secondary)	5. Real-Time Measurements
3. X-Axis	6. Edit Graph

## Breath Triggers

Triggers are used to detect the start of the inspiratory and expiratory breath cycles. Triggers can be based on the flow rate, pressure, or driven from a TTL voltage signal. The Certifier™ Pro Flow Analyzer can automatically detect the breath using the flow rate, or you can manually set your own start and end trigger values using the flow rate or low pressure. In most circumstances, it is recommended to use the Auto Trigger setting.

Triggers

---

Trigger Type  Auto Trigger

Flow Rate

Pressure (Advanced Users)

Flow Direction (TTL)

Trigger Type  Auto Trigger

Flow Rate

Pressure (Advanced Users)

Flow Direction (TTL)

Start  L/min ▾

End  L/min ▾

## Breath Averaging

The number of breaths specifies the maximum number of breaths over which to average breath parameter measurements. The averaging time sets the rate at which real-time values are averaged and updated on the Certifier™ Pro display. Real-time values include measurements for flow rate, low pressure, high pressure, absolute pressure, oxygen concentration (if connected), and temperature.



**Trigger:** Flow/Auto

**Breaths:** 5 of 5

**Average Time:** 0.5 s

## Certifier™ Flow Analyzer Configurations

A Certifier™ Flow Analyzer configuration is a saved collection of settings for the measurements, units, gas type and conditions, triggering, and graphing that you have selected. Any Certifier™ setup can be saved as a configuration and later recalled. Configurations can be saved for testing various types of equipment or to optimize test setups to conform with organizational standards or personal preference.

Configurations are stored in the internal memory of the 4090 Certifier™ Pro instrument and can be exported to a USB mass storage drive via either USB-A port. Exported configurations can be sent as email attachments and they can be imported onto different Certifier™ Pro or Certifier™ Plus instruments.

## Data Acquisition

The Certifier Pro Flow Analyzer is capable of logging measurement data and capturing screenshots. Data can be saved from either the Parameter or Graph screen, and files are saved to the internal memory of the Certifier Pro Flow Analyzer.

Snapshots save a screenshot image as well as the data currently displayed on screen. Continuous logging captures data for all measurements selected on screen at sample rate of 1 sec to 10 mins and test length from 15 secs to up to 5 days. Waveform logging records raw sensor data at a rate of 1000 Hz for a length of 15 to 60 seconds.

## Data Export

Saved screenshots and data log files can be exported from either of the two USB-A ports located on the back of the 4090 Certifier Pro Flow Analyzer. Snapshots are exported as .png image files and data is exported as .csv files. The delimiter for data export can be set as comma, pipe, semicolon, or tab delimited. You can select the Export Delimiter in the General Settings page of the Settings menu option.

---

TSI and TSI logo are registered trademarks of TSI Incorporated in the United States and may be protected under other country's trademark registrations.



**Knowledge Beyond Measure.**

**TSI Incorporated** – Visit our website [www.tsi.com](http://www.tsi.com) for more information.

**USA** Tel: +1 800 680 1220  
**UK** Tel: +44 149 4 459200  
**France** Tel: +33 1 41 19 21 99  
**Germany** Tel: +49 241 523030

**India** Tel: +91 80 67877200  
**China** Tel: +86 10 8219 7688  
**Singapore** Tel: +65 6595 6388

