

PresSura™ Room Pressure Controller Model RPC30



Operation and Service Manual

P/N 6006643, Revision L
February 2023



Start Seeing the Benefits of Registering Today!

Thank you for your TSI® instrument purchase. Occasionally, TSI® releases information on software updates, product enhancements and new products. By registering your instrument, TSI® will be able to send this important information to you.

<http://register.tsi.com>

As part of the registration process, you will be asked for your comments on TSI products and services. TSI's customer feedback program gives customers like you a way to tell us how we are doing.

PresSura™ Room Pressure Controller Model RPC30



Operation and Service Manual

P/N 6006643, Revision L
February 2023

U.S. and Canada

Sales & Customer Service:

(800) 680-1220 / (651) 490-2860

Fax:

(651) 490-3824

Ship/Mail To:

TSI Incorporated
ATTN: Customer Service
500 Cardigan Road
Shoreview, MN 55126
USA

Other Countries

Sales & Customer Service:

(001 651) 490-2860

Fax:

(001 651) 490-3824

E-mail

technical.services@tsi.com

Web Site

www.tsi.com



WARNING

These Instruments **MUST** be used in the manner described in this manual. Failure to follow all of the procedures described in this manual can result in serious injury or death. There are no user-serviceable parts inside the instrument. Refer all repairs to a qualified factory-authorized technician.

(This page intentionally left blank)

Part number 6006643 / Rev L / February 2023

Limitation of Warranty and Liability (effective April 2014)

(For country-specific terms and conditions outside of the USA, please visit www.tsi.com.)

Seller warrants the goods, excluding software, sold hereunder, under normal use and service as described in the operator's manual, to be free from defects in workmanship and material for **24 months**, or if less, the length of time specified in the operator's manual, from the date of shipment to the customer. This warranty period is inclusive of any statutory warranty. This limited warranty is subject to the following exclusions and exceptions:

- a. Hot-wire or hot-film sensors used with research anemometers, and certain other components when indicated in specifications, are warranted for 90 days from the date of shipment;
- b. Pumps are warranted for hours of operation as set forth in product or operator's manuals;
- c. Parts repaired or replaced as a result of repair services are warranted to be free from defects in workmanship and material, under normal use, for 90 days from the date of shipment;
- d. Seller does not provide any warranty on finished goods manufactured by others or on any fuses, batteries or other consumable materials. Only the original manufacturer's warranty applies;
- e. This warranty does not cover calibration requirements, and seller warrants only that the instrument or product is properly calibrated at the time of its manufacture. Instruments returned for calibration are not covered by this warranty;
- f. This warranty is **VOID** if the instrument is opened by anyone other than a factory authorized service center with the one exception where requirements set forth in the manual allow an operator to replace consumables or perform recommended cleaning;
- g. This warranty is **VOID** if the product has been misused, neglected, subjected to accidental or intentional damage, or is not properly installed, maintained, or cleaned according to the requirements of the manual. Unless specifically authorized in a separate writing by Seller, Seller makes no warranty with respect to, and shall have no liability in connection with, goods which are incorporated into other products or equipment, or which are modified by any person other than Seller.

The foregoing is **IN LIEU OF** all other warranties and is subject to the **LIMITATIONS** stated herein. **NO OTHER EXPRESS OR IMPLIED WARRANTY OF FITNESS FOR PARTICULAR PURPOSE OR MERCHANTABILITY IS MADE. WITH RESPECT TO SELLER'S BREACH OF THE IMPLIED WARRANTY AGAINST INFRINGEMENT, SAID WARRANTY IS LIMITED TO CLAIMS OF DIRECT INFRINGEMENT AND EXCLUDES CLAIMS OF CONTRIBUTORY OR INDUCED INFRINGEMENTS. BUYER'S EXCLUSIVE REMEDY SHALL BE THE RETURN OF THE PURCHASE PRICE DISCOUNTED FOR REASONABLE WEAR AND TEAR OR AT SELLER'S OPTION REPLACEMENT OF THE GOODS WITH NON-INFRINGEMENT GOODS.**

TO THE EXTENT PERMITTED BY LAW, THE EXCLUSIVE REMEDY OF THE USER OR BUYER, AND THE LIMIT OF SELLER'S LIABILITY FOR ANY AND ALL LOSSES, INJURIES, OR DAMAGES CONCERNING THE GOODS (INCLUDING CLAIMS BASED ON CONTRACT, NEGLIGENCE, TORT, STRICT LIABILITY OR OTHERWISE) SHALL BE THE RETURN OF GOODS TO SELLER AND THE REFUND OF THE PURCHASE PRICE, OR, AT THE OPTION OF SELLER, THE REPAIR OR REPLACEMENT OF THE GOODS. IN THE CASE OF SOFTWARE, SELLER WILL REPAIR OR REPLACE DEFECTIVE SOFTWARE OR IF UNABLE TO DO SO, WILL REFUND THE PURCHASE PRICE OF THE SOFTWARE. IN NO EVENT SHALL SELLER BE LIABLE FOR LOST PROFITS, BUSINESS INTERRUPTION, OR ANY SPECIAL, INDIRECT, CONSEQUENTIAL OR INCIDENTAL DAMAGES. SELLER SHALL NOT BE RESPONSIBLE FOR INSTALLATION, DISMANTLING OR REINSTALLATION COSTS OR CHARGES. No Action, regardless of form, may be brought against Seller more than 12 months after a cause of action has accrued. The goods returned under warranty to Seller's factory shall be at Buyer's risk of loss, and will be returned, if at all, at Seller's risk of loss.

Buyer and all users are deemed to have accepted this LIMITATION OF WARRANTY AND LIABILITY, which contains the complete and exclusive limited warranty of Seller. This LIMITATION OF WARRANTY AND LIABILITY may not be amended, modified or its terms waived, except by writing signed by an Officer of Seller.

Service Policy

Knowing that inoperative or defective instruments are as detrimental to TSI as they are to our customers, our service policy is designed to give prompt attention to any problems. If any malfunction is discovered, please contact your nearest sales office or representative, or call TSI's Customer Service department at (800) 680-1220 or (651) 490-2860.

Trademarks

TSI and TSI logo are registered trademarks of TSI Incorporated in the United States and may be protected under other country's trademark registrations. PresSura is a trademark of TSI Incorporated. BACnet is a registered trademark of ASHRAE. Modbus is a registered trademark of Modicon, Inc. LonWorks is a registered trademark of Echelon® Corporation. IBM is a registered trademark of International Business Machines Corporation.

CONTENTS

HOW TO USE THIS MANUAL.....	1
Safety Information	1
Description of Caution Symbol	1
Access Code / Passcode	1
PART ONE	3
User Basics	3
The Instrument	3
Useful User Information.....	3
Operator Panel	3
Display Screen	4
Room Indicator Colors.....	4
Operator Keys	4
USB Port	5
Alarms.....	5
Visual Alarm	5
Audible Alarms	5
Alarm Relays	6
Before Calling TSI	6
PART TWO.....	7
Technical Section	7
Software Programming.....	8
Changing Room Mode	8
Entering Menus	9
Menus and Menu Items.....	9
Entering Data	9
Programming Example.....	10
Menu and Menu Items.....	12
Configure Menu.....	14
ALARM CONSTRAINTS	27
Rm1 Setpnts Menu.....	29
Alarm Config Menu.....	35
Control Menu	37
Interface Menu	40
Diagnostics Menu	46
Calibration.....	69
Room Pressure Calibration	69
Flow Calibration.....	70
Optimizing Controller Performance	73
Maintenance and Repair Parts	74
System Component Inspection	74
Pressure Sensor Cleaning	75
Display Screen Cleaning	75
Replacement Parts.....	76
Troubleshooting Section.....	76
Hardware Test.....	76
Troubleshooting Chart.....	80

APPENDIX A	87
Specifications*	87
APPENDIX B	89
Network Communications.....	89
Modbus® Communications	89
Unique to TSI	89
Network Points RAM Variables	90
XRAM Variables	91
RPC30 Variable List.....	91
LonWorks® Object	97
Node Object Network Variables	97
Room Pressure Controller Object Network Variables	97
Description of LON SNVTs	98
Model RPC30 BACnet® MS/TP Protocol Implementation Conformance Statement.....	99
BACnet® MS/TP Object Set.....	102
APPENDIX C	107
Wiring Information	107
Back Panel Wiring	107
APPENDIX D	123
Access Codes / Passcode.....	123

How to Use This Manual

The Operation and Service Manual describes how to operate, configure, calibrate, maintain and troubleshoot the Model RPC30 Room Pressure Controller. The manual is divided into two parts. [Part one](#) describes the unit and how to interface with the device. This section should be read by users, facilities staff, and anyone who requires a basic understanding of how the device operates.

[Part two](#) describes the technical aspects of the product which include operation, configuration, calibration, maintenance and troubleshooting. Part two should be read by personnel programming or maintaining the unit.

TSI® recommends thoroughly reading this manual before changing any software items.

NOTICE

This operation and service manual assumes that the controller has been properly installed. Refer to the Installation Instructions if there is any question as to whether the controller has been installed properly.

Safety Information

This section gives instructions to promote safe and proper handling of Model RPC30 Room Pressure Controller.

There are no user-serviceable parts inside the instrument. Opening the instrument case will void the warranty. Refer all service of the unit to a qualified technician.

Description of Caution Symbol



CAUTION

Caution indicates:

- Equipment may be damaged if procedures are not followed.
- Improper settings may result in loss of containment.
- Important information about unit operation.

Access Code / Passcode

Model RPC30 Room Pressure Controllers have access codes to limit unauthorized access to the room mode or complete menu system. The access codes can be turned on or off through the Passcode menu item. When the units ship from TSI®, they are configured with the access code off. Refer to Appendix D, [Passcode](#), for instructions on entering the access code.

(This page intentionally left blank)

Part One

User Basics

This section is designed to provide a brief but thorough overview of the product installed. These few pages explain the purpose (The Instrument) and the operation (Useful user information, Operator panel, Alarms) of the product. Technical product information is available in Part Two of the manual.

The Instrument

The Model RPC30 Room Pressure Controller is designed to measure and report room pressure differential in healthcare facilities and other critical environments. It also can measure other parameters, such as supply flow, exhaust flow, relative humidity, room temperature and supply air temperature as part of controlling the room.

Useful User Information

The display of the controller is colored gray, green or red. Green indicates the room pressure differential and other configured measurements are adequate. The display turns red to indicate alarm status when the room pressure differential or another configured measurement has risen above or dropped below a safe level. The display provides additional information depending on the configuration of the unit. Gray indicates that the room is in no isolation mode and will not alarm if room pressure differential is not maintained.

Operator Panel

The Model RPC30 Room Pressure Controllers are easy to use. Normal vs. alarm condition and room mode are always shown on the display. In addition, the displayed can be configured to show the room pressure differential or all measurements. Specific details about the front panel display and controls are described on the following pages. The front panel, shown in Figure 1 and Figure 2 identifies the important features on the display:

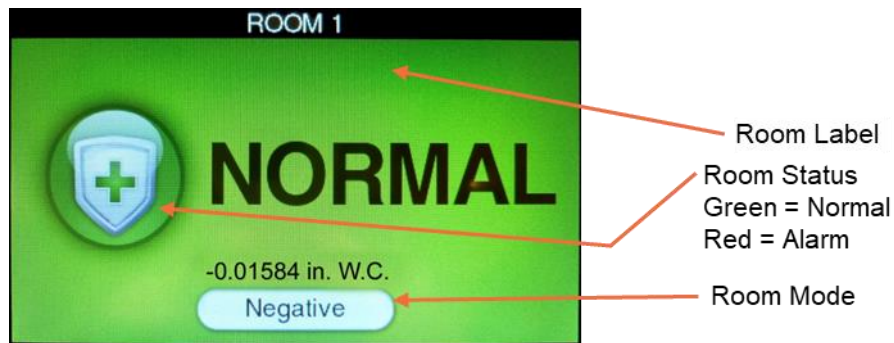

Figure 1. Single Room Screen

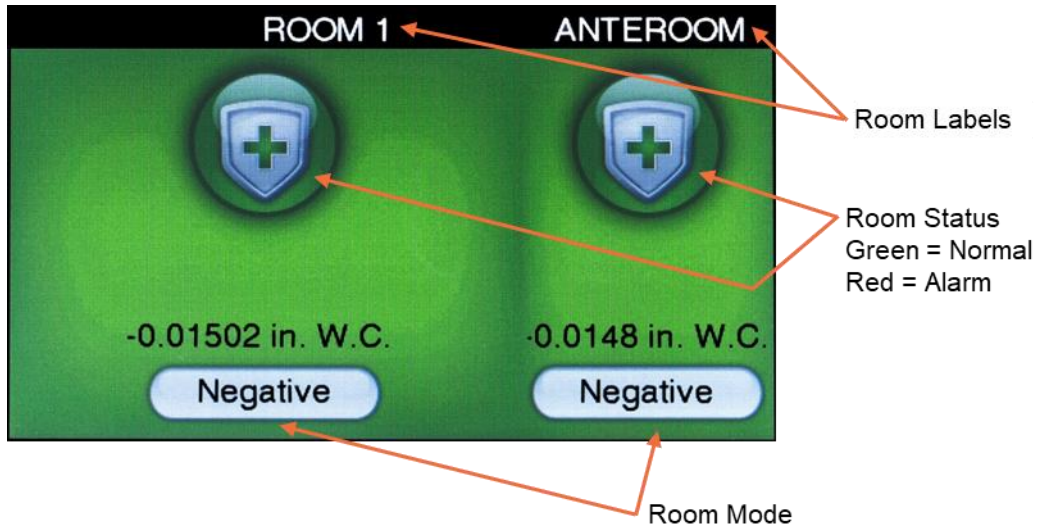

Figure 2. Two Room Screen

Display Screen

The LCD display is highly configurable and can display various critical information including pressure differential, flow rate, alarm status, menu options, and error messages. In addition, the LCD display is used for programming the unit. When programming the unit, the display will show menus, menu items, and current value of the menu item, depending on the specific programming function being performed.

Room Indicator Colors

Green	The screen icon is colored green (NORMAL) when the room pressure and/or other configured measurements are adequate. This light indicates the room is operating safely. If a set point cannot be maintained or an alarm limit has been reached, the green light turns off and the red alarm light turns on.
Red	The room icon is colored red (ALARM) when the room pressure and/or other configured measurements are not within alarm limits. This light indicates the room is not operating safely. The display screen will also indicate the type of alarm or an emergency message.
Gray	The room icon is colored gray to indicate No Isolation mode. In No Isolation mode the Model RPC30 will not alarm.

Operator Keys

The following keys appear on the display of the Model RPC30 room controller:



MUTE key

The **MUTE** key silences an audible alarm. The alarm remains silent until the **MUTE TIME** value has been reached or the unit returns to control set point.



ACKNOWLEDGE key

The **ACKNOWLEDGE** key clears alarms when the Model RPC30 has been set latched alarms under the **ALARM RESET** item.

USB Port

There is a USB port on the case. This USB port can be used with TSI® Incorporated's Configuration Software.

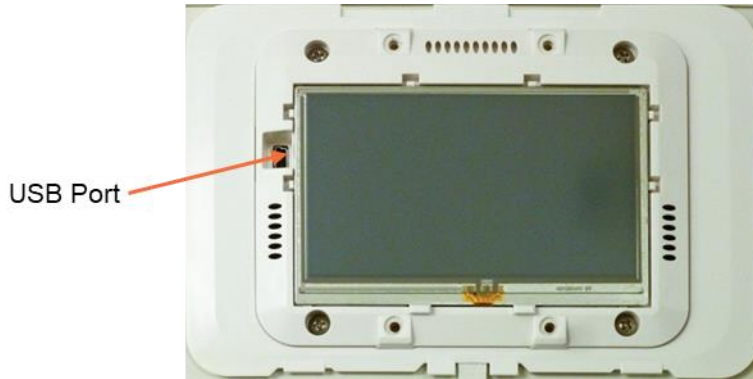

Figure 3. USB Port Location

Alarms

The Model RPC30 controller has visual (red light) and audible alarms to inform you of changing room conditions. The alarm levels (set points) are determined by facilities staff, which could be Engineering, Industrial Hygiene, or a facilities group depending on how the safety staff is organized.

The audible and visual alarms will activate whenever the field configured alarm level is reached. The alarms will activate if the room pressure differential is low or inadequate, high or too great, or when the airflow is too low or too high (need optional flow device installed). When the room is operating safely, no alarms will sound.

Example: The low alarm is preset to activate when the room pressure differential falls below -0.01.0 in. W.C. (closer to neutral). When the room pressure drops to -0.005 in. W.C., for example, the audible and visual alarms activate. The alarms turn off (when set to unlatched) when the unit returns to the safe range, which is defined as 0.001.0 in. W.C. greater than alarm set point (-0.01.0 in. W.C.).

Visual Alarm

The display of the controller turns red to indicate an alarm condition. The icon turns continuously red for all alarm conditions.

Audible Alarms

The audible alarm is continuously on in all low and high alarm conditions. The audible alarm can be silenced by pressing the **MUTE**  key.

If the audible alarm has been muted, the alarm is silenced for a configurable period of time (see menu item **MUTE TIME**) or the measurement returns to the safe range. The safe range is 0.001.0 in. W.C. (50 cfm) above the low alarm set point and 0.001.0 in. W.C. (50 cfm) below the high alarm set point.

The audible and visual alarms can be programmed to either automatically turn off when the unit returns to the safe range or to stay in alarm until the **ACKNOWLEDGE**  key is pressed (See menu item **ALARM RESET**).

Alarm Relays

The PresSura™ controllers feature 2 alarm relays. The alarm relays can be field configured to either open or close to indicate an alarm condition, although they will close on loss of power.

Relay 1 functions as the low alarm relay, and will activate after the alarm delay for low pressure, low flow, low temperature and low RH alarms. Relay 1 will trigger without waiting for the alarm delay to indicate a LOM alarm, or low pressure drop across a venturi valve, if a flow input is configured for venturi valves.

Relay 2 is field-configurable to function as a high alarm relay or to indicate the room status. Refer to the **Relay 2 Out** item in the **Alarm Config** menu for details on this operation.

Before Calling TSI®

This manual should answer most questions and resolve most problems you may encounter. If you need assistance or further explanation, contact your local TSI® representative or TSI®. TSI is committed to providing high quality products backed by outstanding service.

Please have the following information available prior to contacting your authorized TSI Manufacturer's Representative or TSI:

- Model number of unit* RPC30
- Type of room pressure sensor (TSI Through-the-wall sensor or pressure transducer)
- Software revision level*
- Facility where unit is installed

* Can be determined by entering the **Diagnostics** menu.

Due to the different configurations of the Model RPC30 controller available, the above information is needed to accurately answer your questions.

For the name of your local TSI representative or to talk to TSI service personnel, please call TSI at (800) 680-1220 (U.S. and Canada) or (001 651) 490-2860 (other countries).

Prior to shipping any components to TSI for service or repair, please utilize our convenient Service Request Form, which is available online at tsi.com/service.

Part Two

Technical Section

The PresSura™ Room Pressure Controller is ready to use after being properly installed and configured. The TSI® through-the-wall sensor is factory calibrated, as are most pressure transducers. Figure 4 shows the Digital Interface Module (DIM) which is programmed with a default configuration that can be easily modified to fit your application.

The technical section is separated into five parts that cover all aspects of the unit. Each section is written as independently as possible to minimize flipping back and forth through the manual for an answer.



**Figure 4. PresSura™
Room Pressure Controller**

The [Software Programming](#) section explains the programming keys on the DIM. In addition, the programming sequence is described, which is the same regardless of the menu item being changed. At the end of this section is an example of how to program the DIM.

The [Menu and Menu Items](#) section lists all of the software items available to program and change. The items are grouped by menu which means all set points are in one menu, control signal items in another, etc. The menu items and all related information is provided including; programming name, description of menu item, range of programmable values, and how the unit shipped from the factory (default value).

The [Calibration](#) section describes the required procedure to calibrate the controller. This section explains how to compare the controller's reading to a portable thermal anemometer and then adjust the span to establish an accurate calibration. This section also describes how to zero a TSI® flow station transducer (if installed).

The [Maintenance and Repair Parts](#) section covers all routine maintenance of equipment, along with a list of repair parts.

The [Troubleshooting](#) section is split into two areas: mechanical operation of the unit and system performance. Many external variables will affect how the unit functions so it is critical to first determine if the system is having mechanical problems—i.e., no display on unit, alarms do not function, , etc. If no mechanical problems exist, look for performance problems (i.e., does not seem to read correctly, display fluctuates, etc.). The first step is to determine that the system is mechanically operating correctly, followed by modifying the configuration to eliminate the performance problems.

Software Programming

Programming the PresSura™ Model RPC30 controller is quick and easy if the proper keystroke procedure is followed. The programming keys are defined first, followed by the required keystroke procedure. At the end of this section is a programming example.

NOTICE

It is important to note that the unit is always operating when programming. When a menu item value is changed, the new value takes effect **IMMEDIATELY** after saving the change, not when the unit returns to normal operating mode.

This section covers programming the instrument through the keypad and display. If programming through network communications (see [Appendix B](#)), use the host computer's procedure. The changes take place immediately upon saving data in the instrument.

Changing Room Mode

1. Press the **Room Mode** button for the room on the touchscreen.

Room Mode

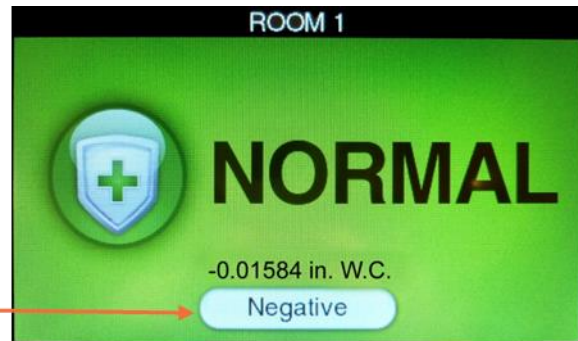

Figure 5. Main Running Screen

2. Select the desired room mode by pressing on the desired room mode button at the bottom of the screen.

NOTICE

If a room mode is not selected, the PresSura™ controller will return to the main running screen after a short delay.

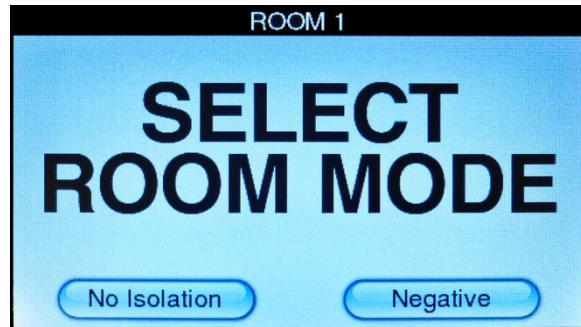

Figure 6. Room Mode Selection Screen

Entering Menus

Swipe across the display, from the top right corner to the bottom left corner, to access the menu system.

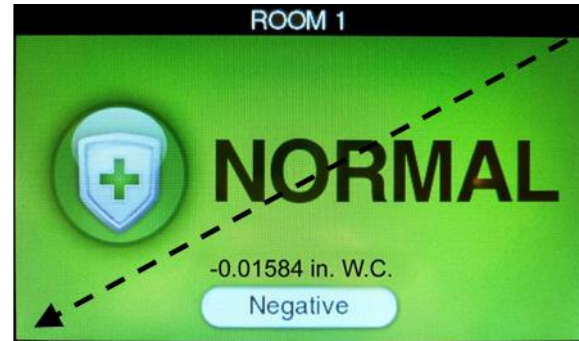

Figure 7. Swipe to access menu system

Menus and Menu Items

After accessing a menu, the screen will change to show the items associated with that menu. Refer to the Menu and Menu Items section for a list of the menus and their associated items.

Entering Data

After entering a menu item, the Model RPC30 controller display will change to select items. Some items have pre-defined choices selected through a drop-down menu; others allow numeric setpoints.

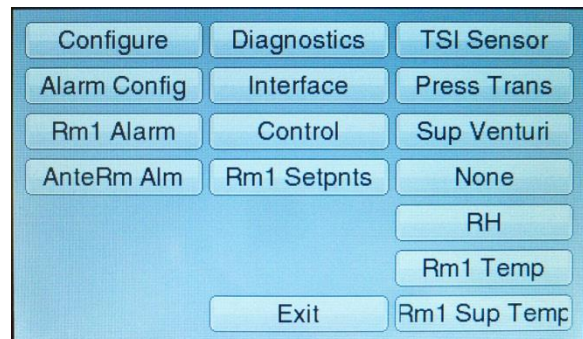

Figure 8. Menu System

Drop-Down Selection

It is easy to view available choices and make a selection from drop-down items. Touch the item displayed in the drop-down box to view all available options. Then, touch the item desired. Touch the **Save** button to save your selection and exit the item or touch the **Cancel** button to exit the item without saving.

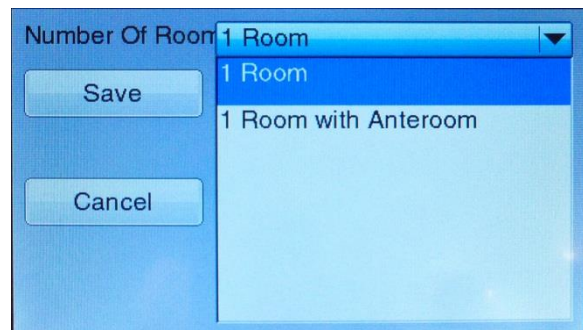

Figure 9. Using a Drop-Down Selection

Numeric Setpoints

It is easy to enter new numeric setpoints on the PresSura™ Model RPC30 controller. On a numeric setpoint screen, the current setpoint is displayed in a box at the top left of the screen.

- Use the numeric keypad to enter a new setpoint.
- The value entered must be between the min and max listed on-screen.
- The measurement units are displayed as units. The <- button deletes the last digit.
- The **Clr** button clears the entire setpoint.
- The **Save** button saves your selection and exits the item.
- The **Cancel** button exits the item without saving changes.

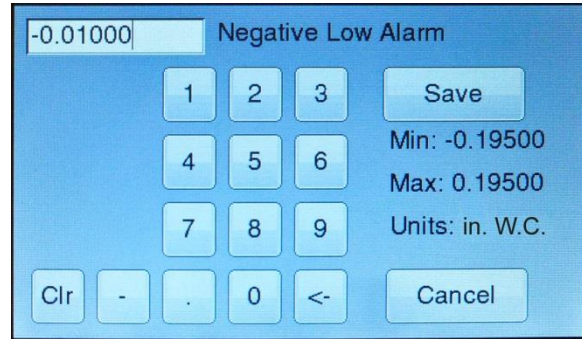
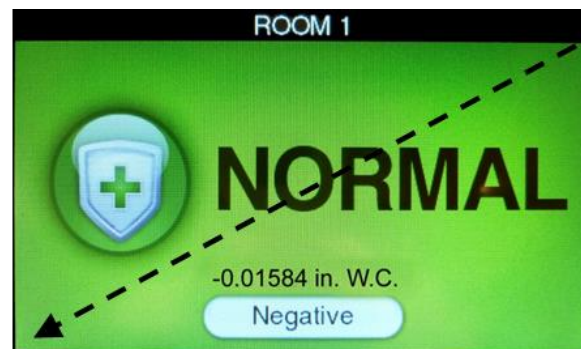
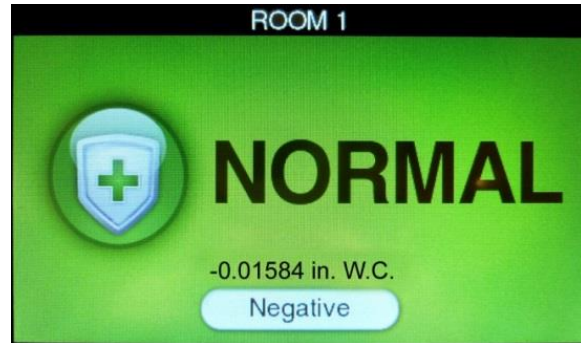

Figure 10. Entering Numeric Setpoints

Programming Example

The following example demonstrates the keystroke sequence. In this example the negative low alarm set point for Room 1 will be changed from -0.01000 in. W.C. to -0.01300 in. W.C.

- 1 Unit is in normal operation.
- 2 Swipe from the top right corner to the bottom left corner to access the menu system.



- 3 The menu screen is displayed.

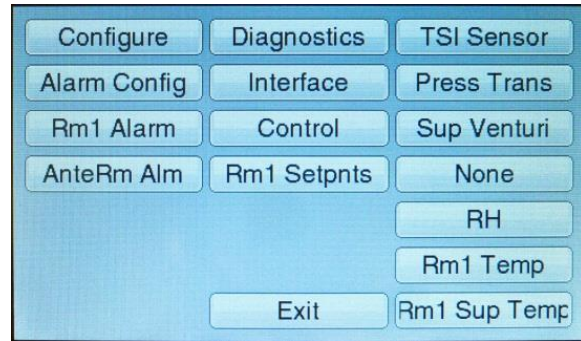

- 4 Select the **Rm1 Alarm** menu.

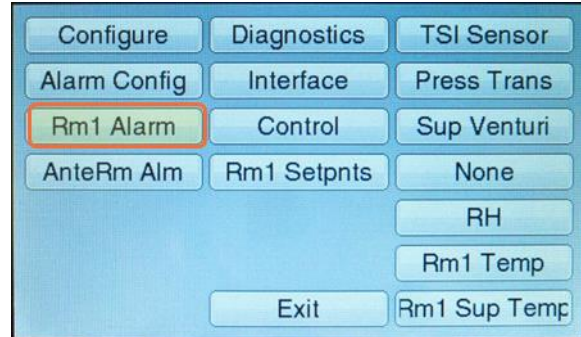

- 5 Select the **Neg Low Alm** item.



- 6 Enter the new setpoint of -0.01300 in. W.C. **Save** the new setting.

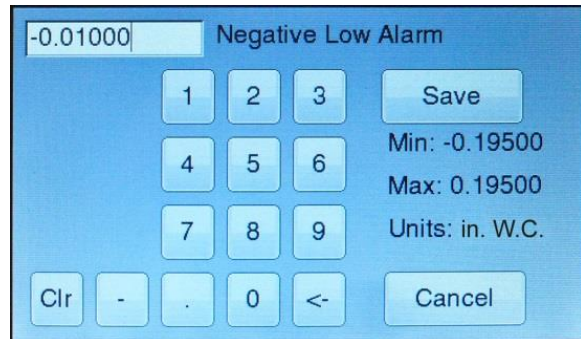

- 7 Touch the **Exit** button in the Rm1 Alarm menu and again in the main menu to return to the main running screen.

Menu and Menu Items

The PresSura™ Model RPC30 controllers are very versatile devices which can be configured to meet your specific application. This section lists all of the menu items available to program and change (except diagnostics menu). Changing items is accomplished by using the touchscreen or through communications with the Building Automation System. If you are unfamiliar with the keystroke procedure please see [Software Programming](#) section for a detailed explanation. This section provides the following information:

- Complete list of menus and all menu items.
- Gives the menu or programming name.
- Defines each menu item's function; what it does, how it does it, etc.
- Gives the range of values that can be programmed.
- Gives default item value (how it shipped from factory).

The menus covered in this section are divided into groups of related items to ease programming. As an example all set points are in one menu, alarm information in another, etc. The manual follows the menus as programmed in the controller. The menu items are always grouped by menu and then listed in menu item order, not alphabetical order. Figure 11 shows the PresSura™ Model RPC30 controller menu items.

Configure	Rm1 Alarm	AnteRm Alarm
# of Rooms	Room Mode	Room Mode
Press Modes	Neg Low Alm	Neg Low Alm
Ctrl Devices	Neg Hi Alm	Neg Hi Alm
Rm1 Label	Pos Low Alm	Pos Low Alm
AnteRm Label	Pos Hi Alm	Pos Hi Alm
Display Meas	Exh Low Alm	Alarm Enable
Display Avg	Sup Low Alm	
Units	Temp Low Alm	
Passcode	Temp Hi Alm	
Num Format	Alarm Enable	
Input 1	ACH Duct	
Input 2	Room1 Vol	
Input 3	RH Low Alm	
Input 4	RH High Alm	
Input 5		
Input 6		
Input 7		

Rm1 Setpnts	Alarm Config	Control	Diagnostics
Neg Setpnt Pos Setpnt No Iso Type No Iso Setpnt Temp Heat Temp Cool Sup Temp Diff Unoc Heat Unoc Cool Min Sup Flow Max Sup Flow Heat Flow Cool Flow Unoc Min Flow Min Sup Pos Max Sup Pos Min Exh Flow Max Exh Flow Min Exh Pos Max Exh Pos	Alarm Reset Audible Alm Alarm Delay Mute Time Door Delay Relay 2 Out Relay 1 Dir Relay 2 Dir	Speed_P Sensitivity_P Speed_F Sensitivity_F Exh Cntl Dir Sup Cntl Dir Temp Dir Temp Thr Temp Ti Sup Kc Exh Kc Sup Ti Exh Ti	View Inputs View Outputs Relay Outputs Flow Control Temp Control Analog Outpt Touch Cal Reset
Interface	Input1 Config	Input2 Config	Input3 Config
Comm Type LON Address MAC ID Baud Rate Nurse Address BACnet Data Stop Bits AO1 Sig Type AO2 Sig Type AO2 Sig Rnge AO2 Out Type AO3 Sig Type AO3 Sig Rnge AO3 Out Type	<i>See menu for items.</i>	<i>See menu for items.</i>	<i>See menu for items.</i>
Input4 Config	Input5 Config	Input6 Config	Input7 Config
<i>See menu for items.</i>	<i>See menu for items.</i>	<i>See menu for items.</i>	<i>See menu for items.</i>

Figure 11. Menu Items – Model RPC30 Controller



Configure Menu

MENU ITEM Monitor/ Controller	SOFTWARE NAME	ITEM DESCRIPTION	ITEM RANGE	DEFAULT VALUE						
Number of Rooms Monitored	# of Rooms	The # of Rooms item selects the number of rooms the Model RPC30 controller will monitor and control.	1 Room 1 Room with Anteroom	1 Room						
Number of Pressure Mode Selections	Press Modes	The Press Modes item determines the room modes available for selection when the user presses the Room Mode button on the main running screen.	2 Buttons, 3 Buttons	2 Buttons						
		<table border="1"> <thead> <tr> <th>Press Mode</th> <th>Room Mode Selections on Screen</th> </tr> </thead> <tbody> <tr> <td>2 Buttons</td> <td>Positive / No Isolation <i>or</i> Negative / No Isolation (based on Room Mode item in respective Alarm menu)</td> </tr> <tr> <td>3 Buttons</td> <td>Negative / No Isolation / Positive</td> </tr> </tbody> </table>			Press Mode	Room Mode Selections on Screen	2 Buttons	Positive / No Isolation <i>or</i> Negative / No Isolation (based on Room Mode item in respective Alarm menu)	3 Buttons	Negative / No Isolation / Positive
		Press Mode			Room Mode Selections on Screen					
		2 Buttons			Positive / No Isolation <i>or</i> Negative / No Isolation (based on Room Mode item in respective Alarm menu)					
3 Buttons	Negative / No Isolation / Positive									
										
WARNING										
		Codes and Standards in the US and many other areas of the world do not allow a room to be switched from Positive to Negative Isolation. Consult local authorities before setting Press Modes to 3 Buttons.								



Configure Menu

MENU ITEM Monitor/ Controller	SOFTWARE NAME	ITEM DESCRIPTION		ITEM RANGE	DEFAULT VALUE
Devices Controlled	Ctrl Devices	The Ctrl Devices item selects what will be controlled in the primary room.		EXHAUST/SUPPLY/ TEMP, EXHAUST, SUPPLY, NONE	EXHAUST
		EXHAUST/ SUPPLY/ TEMP	Configures the Model RPC30 to control room exhaust, supply and heat to maintain ventilation, comfort and room pressure differential.		
		EXHAUST	Configures the Model RPC30 to control the room exhaust to maintain room pressure differential. In this case, ventilation and comfort are not controlled by the Model RPC30 PresSura™ controller.		
		SUPPLY	Configures the Model RPC30 to control the room supply to maintain ventilation, comfort and room pressure differential.		
		NONE	Configures the Model RPC30 to monitor only.		





Configure Menu

MENU ITEM Monitor/ Controller	SOFTWARE NAME	ITEM DESCRIPTION	ITEM RANGE	DEFAULT VALUE
Devices Controlled (continued)		<p style="text-align: center;">NOTICE</p> <p>Ctrl Devices can only be set to EXHAUST/SUPPLY/TEMP if the # of Rooms item is set to 1.</p> <p>If Ctrl Devices is set to EXHAUST/SUPPLY/TEMP, the RPC30 will make the following settings in the Interface menu:</p> <ul style="list-style-type: none"> • AO2 Sig Type = Supply Control • AO2 Out Type = 0 to 10 VDC • AO3 Sig Type = Temp Control <p>If Ctrl Devices is set to NONE or EXHAUST, the RPC30 will set AO2 Sig Type and AO3 Sig Type to None if they were set to SUPPLY CONTROL or TEMP CONTROL.</p> <p>If Ctrl Devices is set to SUPPLY, the RPC30 will set AO1 Sig Type to None, AO2 Sig Type to Supply Control, and AO3 Sig Type to None if it was previously set to TEMP CONTROL.</p>		
Label for Room 1	Rm1 Label	The Rm1 Label item allows the user to set the room number or other designator for room 1.	13 characters of text	ROOM 1
Label for Anteroom	AnteRm Label 	<p>The AnteRm Label item allows the user to set the room number or other designator for the anteroom.</p> <p style="text-align: center;">NOTICE</p> <p>AnteRm Label is only active if the # of Rooms item is set to 1 Room with Anteroom.</p>	13 characters of text	ANTEROOM



Configure Menu

MENU ITEM Monitor/ Controller	SOFTWARE NAME	ITEM DESCRIPTION	ITEM RANGE	DEFAULT VALUE		
Measurements Displayed	Display Meas 	<p>The Display Meas item selects which measurements will be presented on the display during normal operating mode. Use the Units item to choose the units of measure:</p> <p>ROOM STATUS displays the room mode as negative, positive or no isolation.</p> <p>ROOM PRESSURE displays the room mode and the current measurement of room pressure differential.</p> <p>ALL displays the room mode and all currently connected measurements.</p> <table border="1" data-bbox="730 678 1417 837"> <thead> <tr> <th>NOTICE</th> </tr> </thead> <tbody> <tr> <td>Measurements will still enable alarms if not on the display. The measurement will not appear on the display even when in alarm status if not so enabled.</td> </tr> </tbody> </table>	NOTICE	Measurements will still enable alarms if not on the display. The measurement will not appear on the display even when in alarm status if not so enabled.	Room Status, Room Pressure, All	Room Status
NOTICE						
Measurements will still enable alarms if not on the display. The measurement will not appear on the display even when in alarm status if not so enabled.						
Display Average	Display Avg	The Display Avg item selects the display's running average period. The display-averaging period is the length of time the face velocity has been averaged before being displayed. The Display Avg item value may be set between 0.5 and 40 seconds. The higher the averaging value, the more stable the display.	1, 2, 3, 5, 10, 20, or 40 seconds	20 seconds		
Display Units	Units	The Units item selects the unit of measure that the controller displays all values (except calibration span). These units display for all menu items setpoints, alarms, flows, etc.	in. W.C., cfm, F Pa, l/s, C Pa, cmh, C	in. W.C., cfm, F		
Configure INPUT1	Input 1 	<p>The Input 1 item selects the desired input type for Input1, the room pressure sensor for Room 1</p> <p>Go to the Input 1 menu to adjust parameters such as sensor range associated with Input1.</p>	TSI® Sensor, Pressure Transducer	TSI® Sensor		

Configure Menu

MENU ITEM Monitor/ Controller	SOFTWARE NAME	ITEM DESCRIPTION	ITEM RANGE	DEFAULT VALUE
Configure INPUT2	Input 2 	<p>The Input 2 item selects the desired input type for Input2, the room pressure sensor for the AnteRm.</p> <p>Go to the Input2 menu to adjust parameters such as sensor range associated with Input2.</p> <p>The Input 2 item can only be set to TSI® Sensor or Pressure Transducer if the # of Rooms item is set to 1 ROOM WITH ANTEROOM.</p> <p>The Input 2 item can only be set to Temperature Setpoint if the # of Rooms item is set to 1 ROOM.</p>	TSI® Sensor, Pressure Transducer, Temperature Setpoint None	None
Configure INPUT3	Input 3 	<p>The Input 3 item selects the desired input type for Input3.</p> <p>Go to the Input 3 menu to adjust parameters such as sensor range associated with Input3.</p>	Supply Pressure Flow, Supply Linear Flow, Supply Venturi Flow, Supply Switch, None	None
Configure INPUT4	Input 4 	<p>The Input 4 item selects the desired input type for Input4.</p> <p>Go to the Input 4 menu to adjust parameters such as sensor range associated with Input4.</p> <div style="border: 1px solid black; background-color: #0056b3; color: white; text-align: center; padding: 2px;">NOTICE</div> <p>When a door switch is configured for Input 4, opening of the door will hold the air control devices in the last position until the door returns to a closed position.</p>	Room 1 Door Switch, Room 1 Occupancy Sensor, None	None
Configure INPUT5	Input 5 	<p>The Input 5 item selects the desired input type for Input5.</p> <p>Go to the Input 5 menu to adjust parameters such as sensor range associated with Input5.</p>	None Room1 Key Switch, Relative Humidity Sensor	None

Configure Menu

MENU ITEM Monitor/ Controller	SOFTWARE NAME	ITEM DESCRIPTION	ITEM RANGE	DEFAULT VALUE
Configure INPUT6	Input 6 	The Input 6 item selects the desired input type for Input6. Go to the Input 6 menu to adjust parameters such as sensor range associated with Input6.	None, Room1 Temp Sensor, Room1 Door Switch, Anteroom Occupancy Sensor, Anteroom Door Switch	None
Configure INPUT7	Input 7 	The Input 7 item selects the desired input type for Input7. Go to the Input 7 menu to adjust parameters such as sensor range associated with Input7. Input 7 can only be set to ANTEROOM KEYSWITCH if the # of Rooms item is set to 1 ROOM WITH ANTEROOM . Input 7 can only be set to ROOM1 SUPPLY AIR TEMPERATURE if Ctrl Device is set to EXHAUST/SUPPLY/TEMP .	Room1 Supply Air Temperature, Exhaust Pressure Flow, Exhaust Linear Flow, Exhaust Venturi, Exhaust Switch, Anteroom Key Switch, None	None
Number Format	Num Format	The Num Format menu item selects the decimal point.	Period Comma	Period

Configure Menu

MENU ITEM Monitor/ Controller	SOFTWARE NAME	ITEM DESCRIPTION	ITEM RANGE	DEFAULT VALUE												
Enable Access Codes	Passcode	<p>The Passcode item selects whether an access code (pass code) is required to enter the menu items. The Passcode item prevents unauthorized access to a menu. If the Passcode item is:</p> <table border="1" data-bbox="730 480 1417 1070"> <tr> <td data-bbox="730 480 997 557">OFF</td> <td data-bbox="997 480 1417 557">No code is required to enter the room mode or menu screens.</td> </tr> <tr> <td data-bbox="730 557 997 664">ROOM MODE</td> <td data-bbox="997 557 1417 664">Access code is required to enter the room mode screens but not the menu screens.</td> </tr> <tr> <td data-bbox="730 664 997 773">MENUS</td> <td data-bbox="997 664 1417 773">Access code is required to enter the menu screens but not the room mode screens.</td> </tr> <tr> <td data-bbox="730 773 997 881">ALL</td> <td data-bbox="997 773 1417 881">Access code is required to enter the room mode and menu screens.</td> </tr> <tr> <td data-bbox="730 881 997 958">SET ROOM MODE PASSCODE</td> <td data-bbox="997 881 1417 958">Change passcode to select ROOM MODE.</td> </tr> <tr> <td data-bbox="730 958 997 1070">SET MENUS PASSCODE</td> <td data-bbox="997 958 1417 1070">Change passcode to enter Menu system. Contact TSI® to recover a lost password.</td> </tr> </table>	OFF	No code is required to enter the room mode or menu screens.	ROOM MODE	Access code is required to enter the room mode screens but not the menu screens.	MENUS	Access code is required to enter the menu screens but not the room mode screens.	ALL	Access code is required to enter the room mode and menu screens.	SET ROOM MODE PASSCODE	Change passcode to select ROOM MODE .	SET MENUS PASSCODE	Change passcode to enter Menu system. Contact TSI® to recover a lost password.	<p>Off Room Mode Menus All Set Room Mode Passcode Set Menu Passcode</p>	Menus
OFF	No code is required to enter the room mode or menu screens.															
ROOM MODE	Access code is required to enter the room mode screens but not the menu screens.															
MENUS	Access code is required to enter the menu screens but not the room mode screens.															
ALL	Access code is required to enter the room mode and menu screens.															
SET ROOM MODE PASSCODE	Change passcode to select ROOM MODE .															
SET MENUS PASSCODE	Change passcode to enter Menu system. Contact TSI® to recover a lost password.															

Room1 Alarm Menu

MENU ITEM	SOFTWARE NAME	ITEM DESCRIPTION	ITEM RANGE	DEFAULT VALUE												
Mode of Room 1	Room Mode	<p>The Room Mode item selects the room pressure direction. This item enables all related alarms, for pressure direction selected.</p> <p>The PresSura™ Model RPC30 Controller will use the following control parameters:</p> <table border="1"> <thead> <tr> <th>Room Mode</th> <th>Pressure Setpoint</th> <th>Exhaust</th> <th>Supply</th> </tr> </thead> <tbody> <tr> <td>Positive</td> <td>POS SETPOINT</td> <td>Maintains room pressure differential</td> <td>Maintains flow and pressure differential</td> </tr> <tr> <td>Negative</td> <td>NEG SETPOINT</td> <td>Maintains room pressure differential</td> <td>Maintains flow and pressure differential</td> </tr> </tbody> </table> <p></p> <p>NOTICE</p> <p>No Isolation Room Mode can be selected from the main running screen.</p>	Room Mode	Pressure Setpoint	Exhaust	Supply	Positive	POS SETPOINT	Maintains room pressure differential	Maintains flow and pressure differential	Negative	NEG SETPOINT	Maintains room pressure differential	Maintains flow and pressure differential	Positive Negative	Negative
Room Mode	Pressure Setpoint	Exhaust	Supply													
Positive	POS SETPOINT	Maintains room pressure differential	Maintains flow and pressure differential													
Negative	NEG SETPOINT	Maintains room pressure differential	Maintains flow and pressure differential													
Room 1 Alarm Enable	Alarm Enable	<p>The Alarm Enable item enables the low and high alarm functions. When this item is entered, the Model RPC30 will show buttons for Low Alarms and High Alarms. Press the button to toggle between enabling and disabling the alarms.</p> <p>NOTICE</p> <p>The Alarm Enable item enables or disables pressure, flow, temperature and humidity alarms.</p>	Enabled Disabled	Low Alarms Enabled High Alarms Disabled												

Room1 Alarm Menu

MENU ITEM	SOFTWARE NAME	ITEM DESCRIPTION	ITEM RANGE	DEFAULT VALUE
Room 1 Negative Low Alarm	Neg Low Alm	<p>The Neg Low Alm item sets the negative low pressure alarm setpoint. A low alarm condition is defined as when the magnitude of the room pressure falls below the Neg Low Alm setpoint.</p> <p>This item is active when the TSI® key switch is in negative room pressure position or when NEGATIVE is selected in Room Mode item. However, it is always accessible through the menu system.</p>	<p>-0.19500 in. W.C. to +0.19500 in. W.C. (TSI® Sensor)</p> <p>-1.0 in W.C. to +1.0 in W.C. (Pressure Transducer)</p> <p>NOTICE</p> <p>Neg Low Alm cannot be set more negative than the Neg Setpnt</p>	-0.01.0 in. W.C.
Room 1 Negative High Alarm	Neg Hi Alm	<p>The Neg Hi Alm item sets the negative high pressure alarm setpoint. A high alarm condition is defined as when the room is more negative than the Neg Hi Alm setpoint.</p> <p>This item is active when the TSI® key switch is in negative room pressure position or when NEGATIVE is selected in Room Mode item. However, it is always accessible through the menu system.</p>	<p>-0.19500 in. W.C. to +0.19500 in. W.C. (TSI® Sensor)</p> <p>-1.0 in W.C. to +1.0 in W.C. (Pressure Transducer)</p> <p>NOTICE</p> <p>Neg Hi Alm cannot be set less negative than the Neg Setpnt</p>	-0.1.0 in. W.C.

Room1 Alarm Menu

MENU ITEM	SOFTWARE NAME	ITEM DESCRIPTION	ITEM RANGE	DEFAULT VALUE
Room 1 Positive Low Alarm	Pos Low Alm	<p>The Pos Low Alm item sets the positive low pressure alarm setpoint. A low alarm condition is defined as when the room is less positive than the Pos Low Alm setpoint.</p> <p>This item is active when the TSI® key switch is in positive room pressure position or when POSITIVE is selected in Room Mode item. However, it is always accessible through the menu system.</p>	<p>-0.19500 in. W.C. to +0.19500 in. W.C. (TSI® Sensor) -1.0 in W.C. to +1.0 in W.C. (Pressure Transducer)</p> <p>NOTICE Pos Low Alm cannot be set more positive than the Pos Setpnt</p>	+0.01.0 in. W.C.
Room 1 Positive High Alarm	Pos Hi Alm	<p>The Pos Hi Alm item sets the positive high pressure alarm setpoint. A high alarm condition is defined as when the magnitude of the room pressure rises above the Pos Hi Alm setpoint.</p> <p>This item is active when the TSI® key switch is in positive room pressure position or when POSITIVE is selected in Room Mode item. However, it is always accessible through the menu system.</p>	<p>-0.19500 in. W.C. to +0.19500 in. W.C. (TSI® Sensor) -1.0 in W.C. to +1.0 in W.C. (Pressure Transducer)</p> <p>NOTICE Pos Hi Alm cannot be set less positive than the Pos Setpnt</p>	+0.1.0 in. W.C.
Room 1 Low Exhaust Flow Alarm	Exh Low Alm	<p>The Exh Low Alm item sets the minimum exhaust flow alarm setpoint. A minimum flow alarm is defined as when the exhaust flow is less than the Exh Low Alm setpoint.</p>	<p>0 to 30,000 cfm</p> <p>NOTICE Exh Low Alm cannot be set greater than the Min Exh Flow</p>	0 cfm

Room1 Alarm Menu

MENU ITEM	SOFTWARE NAME	ITEM DESCRIPTION	ITEM RANGE	DEFAULT VALUE
Room 1 Low Supply Flow Alarm	Sup Low Alm	The Sup Low Alm item sets the minimum supply flow alarm setpoint. A minimum flow alarm is defined as when the supply flow is less than the Sup Low Alm setpoint.	0 to 30,000 cfm NOTICE Sup Low Alm cannot be set greater than the Min Sup Flow	0 cfm
Room 1 Low Room Temperature Alarm	Temp Low Alm	The Temp Low Alm item sets the minimum room temperature alarm setpoint.	50 to 100°F NOTICE Temp Low Alm cannot be set greater than the Temp Hi Alm	50 °F
High Room Temperature Alarm	Temp Hi Alm	The Temp Hi Alm item sets the maximum room temperature alarm setpoint.	50 to 100°F NOTICE Temp Hi Alm cannot be set less than the Temp Low Alm	100°F
Low Relative Humidity Alarm	RH Low Alm	The RH Low Alm item sets the minimum relative humidity alarm setpoint.	0 to 100% NOTICE RH Low Alm cannot be set greater than the RH Hi Alm	0%
High Relative Humidity Alarm	RH Hi Alm	The RH Hi Alm item sets the maximum relative humidity alarm setpoint.	0 to 100% NOTICE RH Hi Alm cannot be set less than the RH Low Alm	100%

Room1 Alarm Menu

MENU ITEM	SOFTWARE NAME	ITEM DESCRIPTION	ITEM RANGE	DEFAULT VALUE		
Duct for Air Changes per Hour Calculation	ACH Duct	<p>The ACH Duct item sets the duct to be used for ACH calculations:</p> <p>SUPPLY Is normally used for positive rooms. EXHAUST Is normally used for negative rooms. OFF Is used if the ACH calculation is not desired.</p> <table border="1" style="width: 100%;"> <thead> <tr> <th>NOTICE</th> </tr> </thead> <tbody> <tr> <td>The ACH Duct item will only appear if supply and exhaust flows are both configured.</td> </tr> </tbody> </table>	NOTICE	The ACH Duct item will only appear if supply and exhaust flows are both configured.	OFF SUPPLY EXHAUST	OFF
NOTICE						
The ACH Duct item will only appear if supply and exhaust flows are both configured.						
Room Volume	Room1 Vol	The Room1 Vol item sets the room volume for the ACH calculation.	0 to 99,999 ft ³	0 ft ³		

AnteRm Alarm Menu

MENU ITEM	SOFTWARE NAME	ITEM DESCRIPTION	ITEM RANGE	DEFAULT VALUE		
Mode of Anteroom	Room Mode	The Room Mode item selects the room pressure direction. This item enables all related alarms, for pressure direction selected. Selecting ROOM1 means that the Room Mode will follow the Room Mode of Room 1.	Positive Negative Room1	Negative		
Anteroom Negative Low Alarm	Neg Low Alm	<p>The Neg Low Alm item sets the negative low pressure alarm setpoint. A low alarm condition is defined as when the magnitude of the room pressure falls below the Neg Low Alm setpoint.</p> <p>This item is active when the TSI® key switch is in negative room pressure position or when NEGATIVE is selected in Room Mode item. However, it is always accessible through the menu system.</p>	-0.19500 in. W.C. to +0.19500 in. W.C. (TSI® Sensor) -1.0 in W.C. to +1.0 in W.C. (Pressure Transducer) <table border="1" style="width: 100%;"> <thead> <tr> <th>NOTICE</th> </tr> </thead> <tbody> <tr> <td>Neg Low Alm cannot be set more negative than the Neg Hi Alm</td> </tr> </tbody> </table>	NOTICE	Neg Low Alm cannot be set more negative than the Neg Hi Alm	-0.01.0 in. W.C.
NOTICE						
Neg Low Alm cannot be set more negative than the Neg Hi Alm						

AnteRm Alarm Menu

MENU ITEM	SOFTWARE NAME	ITEM DESCRIPTION	ITEM RANGE	DEFAULT VALUE
Anteroom Negative High Alarm	Neg Hi Alm	<p>The Neg Hi Alm item sets the negative high pressure alarm setpoint. A high alarm condition is defined as when the room is more negative than the Neg Hi Alm setpoint.</p> <p>This item is active when the TSI® key switch is in negative room pressure position or when NEGATIVE is selected in Room Mode item. However, it is always accessible through the menu system.</p>	<p>-0.19500 in. W.C. to +0.19500 in. W.C. (TSI® Sensor)</p> <p>-1.0 in W.C. to +1.0 in W.C. (Pressure Transducer)</p> <p>NOTICE</p> <p>Neg Hi Alm cannot be set less negative than the Neg Low Alm</p>	-0.1.0 in. W.C.
Anteroom Positive Low Alarm	Pos Low Alm	<p>The Pos Low Alm item sets the positive low pressure alarm setpoint. A low alarm condition is defined as when the room is less positive than the Pos Low Alm setpoint.</p> <p>This item is active when the TSI® key switch is in positive room pressure position or when POSITIVE is selected in Room Mode item. However, it is always accessible through the menu system.</p>	<p>-0.19500 in. W.C. to +0.19500 in. W.C. (TSI® Sensor)</p> <p>-1.0 in W.C. to +1.0 in W.C. (Pressure Transducer)</p> <p>NOTICE</p> <p>Pos Low Alm cannot be set more positive than the Pos Hi Alm</p>	+0.01.0 in. W.C.

AnteRm Alarm Menu

MENU ITEM	SOFTWARE NAME	ITEM DESCRIPTION	ITEM RANGE	DEFAULT VALUE		
Anteroom Positive High Alarm	Pos Hi Alm	<p>The Pos Hi Alm item sets the positive high pressure alarm setpoint. A high alarm condition is defined as when the magnitude of the room pressure rises above the Pos Hi Alm setpoint.</p> <p>This item is active when the TSI® key switch is in positive room pressure position or when POSITIVE is selected in Room Mode item. However, it is always accessible through the menu system.</p>	<p>-0.19500 in. W.C. to +0.19500 in. W.C. (TSI® Sensor)</p> <p>-1.0 in W.C. to +1.0 in W.C. (Pressure Transducer)</p> <table border="1"> <tr> <td>NOTICE</td> </tr> <tr> <td>Pos Hi Alm cannot be set less positive than the Pos Low Alm</td> </tr> </table>	NOTICE	Pos Hi Alm cannot be set less positive than the Pos Low Alm	+0.1.0 in. W.C.
NOTICE						
Pos Hi Alm cannot be set less positive than the Pos Low Alm						
Anteroom Alarm Enable	Alarm Enable	<p>The Alarm Enable item enables the low and high alarm functions. When this item is entered, the Model RPC30 will show buttons for Low Alarms and High Alarms. Press the button to toggle between enabling and disabling the alarms.</p>	<p>Enabled Disabled</p>	<p>Low Alarms Enabled High Alarms Disabled</p>		

ALARM CONSTRAINTS

There are a number of constraints that prohibit you from incorrectly adjusting the set points. These are as follows:

1. Room mode. The positive pressure alarms are only active when positive control is selected. Negative pressure alarms are only active when negative control is selected. In no isolation mode all alarms are turned off.
2. The PresSura™ controller is programmed with deadbands between alarm setpoints and control setpoints to prevent the controller from cycling between high and low alarms due to normal fluctuations. Setpoint deadbands are:
 - Pressure = 0.001.0 in. W.C.
 - Flow = 50 cfm
 - Temperature = 1°F
 - Relative Humidity = 1%
 - Position = 1% Open

Example: If your control **NEG SETPNT** is set at -0.01.0 in. W.C., the **NEG HI ALARM** setpoint cannot be set less negative than -0.011.0 in. W.C.

3. Alarms do not terminate until the room pressure slightly exceeds the alarm setpoint.
4. The **ALARM RESET** item selects how the alarms will terminate when the controller returns to the safe range. The pressure and flow alarms all terminate the same; they are either latched or unlatched. If unlatched is selected the alarms automatically turn off when the value slightly exceeds the alarm setpoint. If latched is selected, the alarms will not terminate until the pressure or flow exceeds the alarm setpoint *and* the  key is pressed.
5. There is a programmable **ALARM DELAY** that determines how long to delay before activating the alarms. This delay affects all alarms, pressure and flow.
6. The **MUTE TIME** item temporarily turns the audible alarm off for all pressure and flow alarms.
7. The display can only show one alarm message. Therefore, the controller has an alarm priority system, with the highest priority alarm being displayed. If multiple alarms exist, the lower priority alarms will not display until after the highest priority alarm has been eliminated. The alarm priority is as follows:

Room 1 pressure sensor – low alarm
 Room 1 pressure sensor – high alarm
 Room 1 – minimum exhaust flow
 Room 1 – minimum supply flow
 Room 1 – temperature alarms
 Room 1 – relative humidity alarms
 Room 1 – supply venturi (low static pressure) alarm
 Room 1 – exhaust venturi (low static pressure) alarm
 Anteroom pressure sensor – low alarm
 Anteroom pressure sensor – high alarm
 Room 1 – supply airflow-proving switch
 Room 1 – exhaust airflow-proving switch

8. The low and high alarms are absolute values. The chart below shows how the values must be programmed in order to operate correctly.

-1.0 in. W.C. Min Transducer Reading (maximum negative)		+1.0 in. W.C. Max Transducer Reading (maximum positive)	
High Negative Alarm	Low Negative Alarm	Low Positive Alarm	High Positive Alarm

The value of each setpoint or alarm is unimportant (except for small dead band) in graph above. It is important to understand that the high alarm is a greater negative (positive) value than the low alarm.





Rm1 Setpnts Menu

MENU ITEM	SOFTWARE NAME	ITEM DESCRIPTION	ITEM RANGE	DEFAULT VALUE
Room 1 Negative Pressure Setpoint	Neg Setpnt	<p>The Neg Setpnt item sets the negative pressure control setpoint. The PresSura™ controller will maintain the room under negative pressure when item is enabled.</p> <p>This item is active when the TSI® key switch is in negative room pressure position or when NEGATIVE is selected in Room Mode item. However, it is always accessible through the menu system.</p>	<p>0 to -0.19500 in. W.C. (TSI® Sensor) 0 in W.C. to -1.0 in W.C. (Pressure Transducer)</p> <p>NOTICE</p> <p>Neg Setpoint cannot be set less negative than the Neg Low Alm or more negative than the Neg Hi Alm</p>	-0.02 in. W.C.
Room 1 Positive Pressure Setpoint	Pos Setpnt	<p>The Pos Setpnt item sets the positive pressure control setpoint. The PresSura™ controller will maintain the room under positive pressure when item is enabled.</p> <p>This item is active when the TSI® key switch is in positive room pressure position or when POSITIVE is selected in Room Mode item. However, it is always accessible through the menu system.</p>	<p>0 to +0.19500 in. W.C. (TSI Sensor) 0 in W.C. to +1.0 in W.C. (Pressure Transducer)</p> <p>NOTICE</p> <p>Pos Setpoint cannot be set less positive than the Pos Low Alm or more positive than the Pos Hi Alm</p>	+0.02 in. W.C.



Rm1 Setpnts Menu

MENU ITEM	SOFTWARE NAME	ITEM DESCRIPTION	ITEM RANGE	DEFAULT VALUE
Room 1 No Isolation Mode Control	No Iso Type	<p>The No Iso Type item sets the method of control when the PresSura™ controller is in NO ISOLATION mode.</p> <p>If this item is set to:</p> <p>FLOW The PresSura™ controller will maintain an exhaust flow rate when in NO ISOLATION mode.</p> <p>POSITION The PresSura™ controller will maintain the exhaust at a set damper position when in NO ISOLATION mode.</p> <p>PRESSURE The PresSura controller will continue to modulate the exhaust in order to maintain the room pressure differential setpoint, but pressure alarms are inactive.</p>	Flow Position Pressure	Position
Room 1 No Isolation Mode Setpoint	No Iso Setpnt	<p>The No Iso Setpnt item sets the setpoint when the PresSura controller is in NO ISOLATION mode and the No Iso Type item is set to FLOW, POSITION or PRESSURE.</p> <div data-bbox="730 873 1417 922" style="background-color: #0070C0; color: white; text-align: center; padding: 2px;">NOTICE</div> <p>If No Iso Type is set to PRESSURE then the RPC30 will use the Neg Setpnt or Pos Setpnt.</p>	0 to 30,000 CFM 0 to 100%	0%
Room 1 Minimum Temperature for Heating – Normal Mode	Temp Heat 	<p>The Temp Heat item is the temperature at which the heating valve is expected to be fully open. The throttling range of the heating valve is the Temp Cool – Temp Heat.</p> <div data-bbox="730 1149 1417 1198" style="background-color: #0070C0; color: white; text-align: center; padding: 2px;">NOTICE</div> <p>The difference between the Temp Heat and Temp Cool items must be between 1°F and 20°F.</p>	55 to 85°F	68°F



Rm1 Setpnts Menu

MENU ITEM	SOFTWARE NAME	ITEM DESCRIPTION	ITEM RANGE	DEFAULT VALUE
Room 1 Maximum Temperature for Cooling – Normal Mode	Temp Cool 	The Temp Cool item is the temperature at which the heating valve is expected to be fully closed. The throttling range of the heating valve is the Temp Cool – Temp Heat . NOTICE The difference between the Temp Heat and Temp Cool items must be between 1°F and 20°F.	55 to 85°F	73°F
Room 1 Minimum Temperature for Heating – Unoccupied Mode	Unoc Heat 	The Unoc Heat item is the temperature at which the heating valve is expected to be fully open. The throttling range of the heating valve is the Unoc Cool – Unoc Heat . NOTICE The difference between the Unoc Heat and Unoc Cool items must be between 1°F and 20°F.	55 to 85°F	65°F
Room 1 Maximum Temperature for Cooling – Unoccupied Mode	Unoc Cool 	The Unoc Cool item is the temperature at which the heating valve is expected to be fully closed. The throttling range of the heating valve is the Unoc Cool – Unoc Heat . NOTICE The difference between the Unoc Heat and Unoc Cool items must be between 1°F and 20°F.	55 to 85°F	75°F
Room 1 Maximum Supply Air Temperature	Sup Temp Diff 	The Sup Temp Diff item sets the maximum difference between the supply air and room air temperature when heating. NOTICE Input7 must be configured to ROOM1 SUPPLY AIR TEMP SENSOR for this item to active.	10°F to 40°F	20°F



Rm1 Setpnts Menu

MENU ITEM	SOFTWARE NAME	ITEM DESCRIPTION	ITEM RANGE	DEFAULT VALUE
Room 1 Minimum Supply Flow Rate	Min Sup Flow 	<p>The Min Sup Flow item sets the minimum supply flow in Occupied mode.</p> <p>NOTICE</p> <p>Input3 must be configured to measure supply flow for this item to be active.</p> <p>If Min Sup Flow is programmed to be higher than Heat Flow or Cool Flow, Heat Flow or Cool Flow will be reset to the Min Sup Flow setpoint.</p>	0 to 10,000 CFM NOTICE Min Sup Flow cannot be set greater than the Max Sup Flow	0 CFM
Room1 Maximum Supply Flow Rate	Max Sup Flow 	<p>The Max Sup Flow item sets the maximum supply flow.</p> <p>NOTICE</p> <p>Input3 must be configured to measure supply flow for this item to be configured.</p>	0 to 10,000 CFM NOTICE Max Sup Flow cannot be set less than the Min Sup Flow	10,000 CFM
Room1 Heating Supply Flow Rate	Heat Flow 	<p>The Heat Flow item sets the maximum supply flow for heating.</p> <p>NOTICE</p> <p>Input7 must be configured to ROOM1 SUPPLY AIR TEMP SENSOR for this item to be active.</p> <p>Input3 must be configured to measure supply flow for this item to be active.</p> <p>The Cntrl Device item must be set to SUPPLY/EXHAUST/TEMP for this item to be active.</p> <p>This item can be adjusted even if not active.</p> <p>If Min Sup Flow is programmed to be higher than Heat Flow or Cool Flow, Heat Flow or Cool Flow will be reset to the Min Sup Flow setpoint.</p>	0 to 10,000 CFM NOTICE Heat Flow cannot be set greater than the Max Sup Flow or less than the Min Sup Flow	0 CFM

Rm1 Setpnts Menu

MENU ITEM	SOFTWARE NAME	ITEM DESCRIPTION	ITEM RANGE	DEFAULT VALUE
Room1 Cooling Flow Rate	Cool Flow 	<p>The Cool Flow item sets the maximum supply flow for cooling.</p> <p>NOTICE</p> <p>Input3 must be configured to measure supply flow for this item to be active.</p> <p>The Cntrl Device item must be set to SUPPLY/ EXHAUST/TEMP for this item to be active. This item can be adjusted even if not active.</p> <p>If Min Sup Flow is programmed to be higher than Heat Flow or Cool Flow, Heat Flow or Cool Flow will be reset to the Min Sup Flow setpoint.</p>	<p>0 to 10,000 CFM</p> <p>NOTICE</p> <p>Cool Flow cannot be set greater than the Max Sup Flow or less than the Min Sup Flow</p>	0 CFM
Room1 Unoccupied Mode Minimum Supply Flow	Unoc Min Flow 	<p>The Unoc Min Flow item sets the minimum supply flow for unoccupied mode.</p> <p>NOTICE</p> <p>Input3 must be configured to measure supply flow for this item to be active.</p> <p>Input4 or Input6 must be configured accept an occupancy sensor for this item to be active.</p> <p>The Cntrl Device item must be set to SUPPLY/ EXHAUST/TEMP for this item to be active.</p> <p>This item can be adjusted even if not active.</p>	<p>0 to 10,000 CFM</p> <p>NOTICE</p> <p>Unoc Min Flow cannot be set greater than the Max Sup Flow</p>	0 CFM
Room1 Minimum Supply Output	Min Sup Pos 	<p>The Min Sup Pos item sets the minimum output signal to the supply control device.</p> <p>NOTICE</p> <p>The Cntrl Device item must be set to SUPPLY/ EXHAUST/TEMP for this item to be active.</p> <p>This item can be adjusted even if not active.</p>	<p>0 to 100%</p> <p>NOTICE</p> <p>Min Sup Pos cannot be set greater than the Max Sup Pos</p>	0%

Rm1 Setpnts Menu

MENU ITEM	SOFTWARE NAME	ITEM DESCRIPTION	ITEM RANGE	DEFAULT VALUE
Room1 Maximum Supply Output	Max Sup Pos 	The Max Sup Pos item sets the minimum output signal to the supply control device. NOTICE The Cntrl Device item must be set to SUPPLY/ EXHAUST/TEMP for this item to be active. This item can be adjusted even if not active.	0 to 100% NOTICE Max Sup Pos cannot be set less than the Min Sup Pos	100%
Room1 Minimum Exhaust Flow	Min Exh Flow 	The Min Exh Flow item sets the minimum exhaust flow rate for Room1. NOTICE Input7 must be configured for an exhaust flow measurement for this item to be active. This item can be adjusted even if not active. The Min Exh Flow item is only used when the Ctrl Devices item is set to Exhaust.	0 to 10,000 CFM NOTICE Min Exh Flow cannot be set greater than the Max Exh Flow	0 CFM
Room1 Maximum Exhaust Flow	Max Exh Flow 	The Max Exh Flow item sets the maximum exhaust flow rate for Room1. NOTICE Input7 must be configured for an exhaust flow measurement for this item to be active. This item can be adjusted even if not active.	0 to 10,000 CFM NOTICE Max Exh Flow cannot be set less than the Min Exh Flow	0 CFM
Room1 Minimum Exhaust Output	Min Exh Pos	The Min Exh Pos item sets the minimum output signal to the exhaust control device.	0 to 100% NOTICE Min Exh Pos cannot be set greater than the Max Exh Pos	0%

Rm1 Setpnts Menu

MENU ITEM	SOFTWARE NAME	ITEM DESCRIPTION	ITEM RANGE	DEFAULT VALUE
Room1 Maximum Exhaust Output	Max Exh Pos	The Max Exh Pos item sets the maximum output signal to the exhaust control device.	0 to 100% NOTICE Max Exh Pos cannot be set less than the Min Exh Pos	100%

Alarm Config Menu

MENU ITEM	SOFTWARE NAME	ITEM DESCRIPTION	ITEM RANGE	DEFAULT VALUE
Alarm Reset	Alarm Reset	<p>The Alarm Reset item selects how the alarms terminate after the unit returns to control set point. The Alarm Reset affects the audible alarm, visual alarm, and relay output, which means all are latched or unlatched.</p> <p>LATCHED requires the staff to press the  key to clear alarms.</p> <p>UNLATCHED (alarm follow) automatically resets the alarm when the room pressure is:</p> <ul style="list-style-type: none"> • 0.001.0 in. W.C. ft/min greater than the low alarm set point • 0.001.0 in. W.C. ft/min less than the high alarm set point • 50 cfm greater than the low alarm setpoint for flow alarms • 0.3°F for temperature • 0.5% RH 	Latched Unlatched	Unlatched
Enable Sound	Audible Alm	The Audible Alm item enables the beeper on the PresSura™ controller.	On, Off	Off

Alarm Config Menu

MENU ITEM	SOFTWARE NAME	ITEM DESCRIPTION	ITEM RANGE	DEFAULT VALUE
Alarm Delay	Alarm Delay	The Alarm Delay item sets the period of time the room pressure differential, flow or temperature must be above the high alarm set point or below the low alarm set point before the controller enters alarm mode. Use the Alarm Delay function to avoid momentary, nuisance alarms.	1 to 600 seconds	20 seconds
Door Delay	Door Delay	<p>The Door Delay item sets the period of time the room pressure differential, flow or temperature must be above the high alarm set point or below the low alarm set point before the controller enters alarm mode when the door is open. Use the Door Delay function to avoid momentary, nuisance alarms.</p> <div style="border: 1px solid black; padding: 5px; margin: 10px 0;"> <p style="text-align: center;">NOTICE</p> <p>Input4 Config or Input6 Config must be set to DOOR SWITCH for the Door Delay to take effect. Door Delay can be configured even if Input 4 or Input 6 is not set to DOOR SWITCH.</p> </div>	1 to 600 seconds	60 seconds
Mute Timeout	Mute Time	The Mute Time item sets the length of time the audible alarm will be silenced if the mute button is pressed. The Mute Time can be set from 1 to 60 minutes.	1 to 60 Minutes	5 Minutes
Relay2 Output Signal	Relay 2 Out	<p>The Relay 2 Out item sets desired alarm output to be used with Relay 2. If set to:</p> <p>HIGH ALARM The PresSura™ controller will activate the relay if a high alarm condition exists.</p> <p>NEGATIVE ROOM The PresSura™ controller will activate the relay when the mode for Room 1 is Negative.</p> <p>POSITIVE ROOM The PresSura™ controller will activate the relay when the mode for Room 1 is Positive.</p>	High Alarm Negative Room Positive Room	High Alarm
Relay 1 Output Direction	Relay 1 Dir	The Relay 1 Dir item sets desired signal output to be used with Relay 1.	OK = OPEN OK = CLOSED	OK = OPEN

Alarm Config Menu

MENU ITEM	SOFTWARE NAME	ITEM DESCRIPTION	ITEM RANGE	DEFAULT VALUE
Relay 2 Output Direction	Relay 2 Dir	<p>The Relay 2 Dir item sets desired signal output to be used with Relay 2.</p> <p>If Relay 2 Out is set to HIGH ALARM.</p> <p>If Relay 2 Out is set to NEGATIVE ROOM or POSITIVE ROOM.</p>	<p>OK = OPEN OK = CLOSED</p> <p>NO ISO = OPEN NO ISO = CLOSED</p>	<p>OK = OPEN</p> <p>NO ISO = OPEN</p>

Control Menu

MENU ITEM	SOFTWARE NAME	ITEM DESCRIPTION	ITEM RANGE	DEFAULT VALUE
Pressure Control Speed	Speed_P	The Speed_P item selects the control output speed. The greater the Speed_P setting, the faster the control output.	10% to 100%	80%
Pressure Control Sensitivity	Sensitivity-P	<p>The Sensitivity_P item selects the integral dead band. The integral dead band determines when the controller uses integral control (slow control), and when the controller enters PID control (fast control).</p> <p>Each % of Sensitivity_P represents 1 ft/min that the room pressure must be away from set point before the Model RPC30 controller enters PID control (fast control). For example, if the Sensitivity is set to 80% and the set point is 100 ft/min, the room pressure must drop below 80 ft/min or rise above 120 ft/min for the controller to enter PID control.</p>	10% to 100%	80%
				
		WARNING		
		Controller may hunt if Sensitivity is set too high, resulting in poor control and loss of containment.		
Flow Control Speed	Speed_F	The Speed_F item selects the control output speed. The greater the Speed_F setting, the faster the control output.	10% to 100%	80%

Control Menu

MENU ITEM	SOFTWARE NAME	ITEM DESCRIPTION	ITEM RANGE	DEFAULT VALUE
Flow Control Sensitivity	Sensitivity_F	<p>The Sensitivity_F item selects the integral dead band. The integral dead band determines when the controller uses integral control (slow control), and when the controller enters PID control (fast control).</p> <p>Each % of Sensitivity_F represents 5 cfm that the flow rate must be away from set point before the Model RPC30 controller enters PID control (fast control). For example, if the Sensitivity_F is set to 80% and the set point is 500 cfm, the flow must drop below 400 cfm or rise above 600 cfm for the controller to enter PID control.</p>	10% to 100%	80%
Exhaust Control Direction	Exh Cntl Dir	The Exh Cntl Dir item determines the control signal's output direction. As an example: if the control system closes the exhaust damper instead of opening the damper, this option will reverse the control signal to now open the damper.	Direct Reverse	Direct
Supply Control Direction	Sup Cntl Dir	The Sup Cntl Dir item determines the control signal's output direction. As an example: if the control system closes the supply damper instead of opening the damper, this option will reverse the control signal to now open the damper.	Direct Reverse	Direct
Temperature Control Direction	Temp Dir	The Temp Dir item determines the control signal's output direction. As an example: if the control system closes the heating valve instead of opening the valve, this option will reverse the control signal to now open the valve.	Direct Reverse	Direct
Temperature Throttling Range	Temp Thr	The Temp Thr item determines the throttling range, or number of degrees that the room temperature must change in order to go from full heating to no heating or from full cooling to no cooling.	2°F to 20°F	6°F
Temperature Integral Time	Temp Ti	The Temp Ti item determines the integral time of the temperature control loop.	0.000 to 10000.000 seconds	1.000 seconds

Control Menu

MENU ITEM	SOFTWARE NAME	ITEM DESCRIPTION	ITEM RANGE	DEFAULT VALUE
Pressure and Flow Control Coefficients	Sup Kc Exh Kc Sup Ti Exh Ti	<p>The Sup Kc and Exh Kc items change the gain control coefficient. When this item is entered, a value for Sup Kc or Exh Kc is indicated on the display. If the controller is not controlling correctly (hunting, oscillating, or controlling slowly) the Sup Kc or Exh Kc control coefficient may need adjusting. Decreasing Sup Kc or Exh Kc will slow the control system down making it more stable.</p> <p>The Sup Ti and Exh Ti items change the integral control coefficient. When this item is entered, a value for Sup Ti or Exh Ti is indicated on the display. If the controller is not controlling correctly, the unit may have an inappropriate Sup Ti or Exh Ti control coefficient. Increasing Sup Ti or Exh Ti will slow the control system down making it more stable.</p> <div data-bbox="606 781 699 862" style="text-align: center;"> </div> <div data-bbox="716 769 1444 824" style="text-align: center; background-color: #FFD700;"> <p>WARNING</p> </div> <p>The Sup Kc, Exh Kc, Sup Ti and Exh Ti items provide you with the ability to manually change the PI control loop variables. DO NOT CHANGE THESE VALUES UNLESS YOU HAVE A THOROUGH UNDERSTANDING OF PID CONTROL LOOPS. CONTACT TSI FOR ASSISTANCE PRIOR TO CHANGING ANY VALUES. Incorrectly changing a value will result in poor or non-existent control.</p> <p>Suggestion: Before changing Sup Kc, Exh Kc, Sup Ti or Exh Ti, change the Speed or adjust the Sensitivity to try to eliminate the problem.</p>	<p>Sup Kc = 0 to 10,000 Exh Kc = 0 to 10,000 Sup Ti = 0 to 10,000 Exh Ti = 0 to 10,000</p> <p>The range of values is very large. Poor control may occur if values are more than twice or less than 1/2 the default value</p>	<p>Sup Kc = 75 Exh Kc = 75 Sup Ti = 150 Exh Ti = 150</p>



Interface Menu

MENU ITEM	SOFTWARE NAME	ITEM DESCRIPTION	ITEM RANGE	DEFAULT VALUE
Network Communications Protocol	Comm Type	<p>The Comm Type item selects the communications protocol used to interface with the building management system.</p> <p style="text-align: center;">NOTICE</p> <p>LON can only be selected on the Model RPC30-LON.</p>	Modbus® BACnet® LON	Modbus
Network Address	Address	<p>The Address item sets the main network address of the room pressure controller. Each unit on the network must have its own unique address.</p> <p style="text-align: center;">NOTICE</p> <p>The Address item is only functional when Comm Type is set to Modbus or BACnet.</p> <p style="text-align: center;">NOTICE</p> <p>Changes to the Address may take up to 1 minute to take effect when using BACnet® communications.</p>	Modbus: 1 TO 247 BACnet: 1 to 128	128
MAC ID	MAC ID	<p>The MAC ID item is the Device ID of the unit for BACnet® communications.</p> <p style="text-align: center;">NOTICE</p> <p>The MAC ID item is only functional when Comm Type is set to BACnet.</p> <p style="text-align: center;">NOTICE</p> <p>Changes to the MAC ID may take up to 1 minute to take effect when using BACnet® communications.</p>	1 to 4,194,302	606
Baud Rate	Baud Rate	<p>The Baud Rate item sets the communication speed of the PresSura™ controller when using Modbus® or BACnet® communications.</p> <p style="text-align: center;">NOTICE</p> <p>Changes to the Baud Rate may take up to 1 minute to take effect when using BACnet® communications.</p> <p>Baud Rate is not configurable when Comm Type is set to Modbus®.</p>	Modbus: 9600 BACnet: 9600, 19200, 38400, 76800, AutoBaud	Modbus: 9600 BACnet: AutoBaud



Interface Menu

MENU ITEM	SOFTWARE NAME	ITEM DESCRIPTION	ITEM RANGE	DEFAULT VALUE		
Network Address for Nurse's Station	Nurse Address	<p>The Nurse Address item sets the main network address of the room pressure controller when communicating with the Nurse's Station Monitor. Each unit on the network must have its own unique address.</p> <table border="1"> <thead> <tr> <th>NOTICE</th> </tr> </thead> <tbody> <tr> <td> <p>PresSura™ Model RPM10, RPM20 and RPC30 monitors/controllers will have rooms displayed on the Nurse's Station Monitor in order of the Nurse Address. The PresSura™ controller with the lowest Nurse Address will be displayed at the top-left of the Nurse's Station Monitor screen. If a PresSura™ controller is configured for more than 1 room, then the rooms will be displayed on the Nurse's Station in order of Room 1, Room 2, and Anteroom.</p> </td> </tr> </tbody> </table>	NOTICE	<p>PresSura™ Model RPM10, RPM20 and RPC30 monitors/controllers will have rooms displayed on the Nurse's Station Monitor in order of the Nurse Address. The PresSura™ controller with the lowest Nurse Address will be displayed at the top-left of the Nurse's Station Monitor screen. If a PresSura™ controller is configured for more than 1 room, then the rooms will be displayed on the Nurse's Station in order of Room 1, Room 2, and Anteroom.</p>	1 to 8	1
NOTICE						
<p>PresSura™ Model RPM10, RPM20 and RPC30 monitors/controllers will have rooms displayed on the Nurse's Station Monitor in order of the Nurse Address. The PresSura™ controller with the lowest Nurse Address will be displayed at the top-left of the Nurse's Station Monitor screen. If a PresSura™ controller is configured for more than 1 room, then the rooms will be displayed on the Nurse's Station in order of Room 1, Room 2, and Anteroom.</p>						
BACnet Inputs	BACnet Data	<p>The BACnet Data item allows for Relative Humidity to be read over BACnet® instead of being wired to the RPC30. Selecting the button "ON" will allow the Relative Humidity Input to be written to the RPC30 and displayed on the touchscreen.</p> <table border="1"> <thead> <tr> <th>NOTICE</th> </tr> </thead> <tbody> <tr> <td> <p>The BACnet data item only applies when BACnet® is used.</p> </td> </tr> </tbody> </table>	NOTICE	<p>The BACnet data item only applies when BACnet® is used.</p>	ON or OFF	OFF
NOTICE						
<p>The BACnet data item only applies when BACnet® is used.</p>						
Stop Bits (When using Modbus) <i>RPM10 and RPM20</i>	Stop Bits	The Stop Bits items select the number of stop bits used in Modbus® communication.	1 or 2	1		



Interface Menu

MENU ITEM	SOFTWARE NAME	ITEM DESCRIPTION	ITEM RANGE	DEFAULT VALUE
LON Configuration	LON	<p>When the SERVICE PIN option is selected, the Model RPC30 sends a broadcast message containing its Neuron ID and program ID. This is required to install the Model RPC30 on the LonWorks® network, or to reinstall the Model RPC30 after using the GO UNCONFIGURED command.</p> <p>Selecting the GO UNCONFIGURED option resets the Model RPC30 controller's authentication key. This is required in the event a foreign network tool inadvertently acquires a Model RPC30 and installs it with network management authentication. The Model RPC30 controller's owner will then be unable to reclaim the Model RPC30 over the network.</p> <p style="text-align: center;">NOTICE</p> <p>The LON item is only functional when Comm Type is set to LON.</p>	Service Pin Go Unconfigured	N/A
Analog Output Signal Type	AO1 Sig Type 	<p>The AO1 Sig Type item selects the measurement that the analog output signal will represent.</p> <p style="text-align: center;">NOTICE</p> <p>Changing the AO1 Sig Type item when Ctrl Device is set to EXHAUST or EXHAUST/SUPPLY/TEMP may result in loss of room or temperature control.</p>	Exhaust Control, AnteRoom Pressure, None	Exhaust Control
Analog Output Signal Type	AO2 Sig Type 	<p>The AO2 Sig Type item selects the measurement that the analog output signal will represent.</p> <p style="text-align: center;">NOTICE</p> <p>Changing the AO2 Sig Type item when Ctrl Device is set to EXHAUST/SUPPLY/TEMP may result in loss of room or temperature control.</p>	Room 1 Pressure, Exhaust Flow, Supply Control, None	Room 1 Pressure

Interface Menu

MENU ITEM	SOFTWARE NAME	ITEM DESCRIPTION	ITEM RANGE	DEFAULT VALUE																								
Analog Output Signal	AO2 Out Type 	<p>The AO2 Out Type item selects the analog output (not control output signal).</p> <table border="1"> <thead> <tr> <th colspan="3">NOTICE</th> </tr> </thead> <tbody> <tr> <td colspan="3">Changing the AO2 Out Type item when Ctrl Device is set to EXHAUST/SUPPLY/TEMP may result in loss of room or temperature control.</td> </tr> </tbody> </table>	NOTICE			Changing the AO2 Out Type item when Ctrl Device is set to EXHAUST/SUPPLY/TEMP may result in loss of room or temperature control.			0 to 10 VDC or 4-20 mA	0 to 10 VDC																		
NOTICE																												
Changing the AO2 Out Type item when Ctrl Device is set to EXHAUST/SUPPLY/TEMP may result in loss of room or temperature control.																												
Analog Output Full Scale	AO2 Sig Rnge 	<p>The AO2 Sig Rnge item selects the full scale range that the analog output signal will represent. If the room pressure sensor is set to:</p> <table border="1"> <thead> <tr> <th>AO2 SIGNAL TYPE (SENSOR)</th> <th>0 V / 4 mA</th> <th>10 V / 20 mA</th> </tr> </thead> <tbody> <tr> <td>ROOM 1 PRESSURE (TSI®)</td> <td>- AO2 Sig Rnge</td> <td>+ AO2 Sig Rnge</td> </tr> <tr> <td>ROOM 1 PRESSURE (PRESSURE TRANSDUCER; SENSOR MIN=0)</td> <td>0</td> <td>AO2 Sig Rnge</td> </tr> <tr> <td>ROOM 1 PRESSURE (PRESSURE TRANSDUCER; SENSOR MIN≠0)</td> <td>- AO2 Sig Rnge</td> <td>+ AO2 Sig Rnge</td> </tr> <tr> <td>EXHAUST FLOW</td> <td>0</td> <td>AO2 Sig Rnge</td> </tr> </tbody> </table> <table border="1"> <thead> <tr> <th colspan="3">NOTICE</th> </tr> </thead> <tbody> <tr> <td colspan="3">If Ctrl Device is set to EXHAUST/SUPPLY/TEMP, the AO2 Sig Rnge item will not be accessible.</td> </tr> <tr> <td colspan="3">DO NOT set AO2 Sig Rnge to a value greater than the sensor input.</td> </tr> </tbody> </table>	AO2 SIGNAL TYPE (SENSOR)	0 V / 4 mA	10 V / 20 mA	ROOM 1 PRESSURE (TSI®)	- AO2 Sig Rnge	+ AO2 Sig Rnge	ROOM 1 PRESSURE (PRESSURE TRANSDUCER; SENSOR MIN=0)	0	AO2 Sig Rnge	ROOM 1 PRESSURE (PRESSURE TRANSDUCER; SENSOR MIN≠0)	- AO2 Sig Rnge	+ AO2 Sig Rnge	EXHAUST FLOW	0	AO2 Sig Rnge	NOTICE			If Ctrl Device is set to EXHAUST/SUPPLY/TEMP , the AO2 Sig Rnge item will not be accessible.			DO NOT set AO2 Sig Rnge to a value greater than the sensor input.			PRESSURE: -1.00 in. W.C. to +1.00 in. W.C. FLOW: 0 to 30,000 CFM	PRESSURE: 0.10 in. W.C. FLOW: 1000 CFM
AO2 SIGNAL TYPE (SENSOR)	0 V / 4 mA	10 V / 20 mA																										
ROOM 1 PRESSURE (TSI®)	- AO2 Sig Rnge	+ AO2 Sig Rnge																										
ROOM 1 PRESSURE (PRESSURE TRANSDUCER; SENSOR MIN=0)	0	AO2 Sig Rnge																										
ROOM 1 PRESSURE (PRESSURE TRANSDUCER; SENSOR MIN≠0)	- AO2 Sig Rnge	+ AO2 Sig Rnge																										
EXHAUST FLOW	0	AO2 Sig Rnge																										
NOTICE																												
If Ctrl Device is set to EXHAUST/SUPPLY/TEMP , the AO2 Sig Rnge item will not be accessible.																												
DO NOT set AO2 Sig Rnge to a value greater than the sensor input.																												

Interface Menu

MENU ITEM	SOFTWARE NAME	ITEM DESCRIPTION	ITEM RANGE	DEFAULT VALUE
Analog Output Signal Type	AO3 Sig Type 	<p>The AO3 Sig Type item selects the measurement that the analog output signal will represent.</p> <p>NOTICE</p> <p>Changing the AO3 Sig Type item when Ctrl Device is set to EXHAUST/SUPPLY/TEMP may result in loss of room or temperature control.</p>	Anteroom Pressure Supply Flow Exhaust Flow Temp Control None	Anteroom Pressure
Analog Output Signal	AO3 Out Type 	<p>The AO3 Out Type item selects the analog output (not control output signal).</p> <p>NOTICE</p> <p>Changing the AO3 Out Type item when Ctrl Device is set to EXHAUST/SUPPLY/TEMP may result in loss of room or temperature control.</p>	0 to 10 VDC or 4-20 mA	0 to 10 VDC

Interface Menu

MENU ITEM	SOFTWARE NAME	ITEM DESCRIPTION	ITEM RANGE	DEFAULT VALUE		
Analog Output Full Scale	AO3 Sig Rnge	The AO3 Sig Rnge item selects the full scale range that the analog output signal will represent. If the room pressure sensor is set to:	PRESSURE: -1.00 in. W.C. to +1.00 in. W.C. FLOW: 0 to 30,000 CFM	PRESSURE: 0.10 IN. W.C. FLOW: 1000 CFM		
		AO3 SIGNAL TYPE (SENSOR)			0 V / 4 mA	10 V / 20 mA
		ANTEROOM PRESSURE (TSI®)			-AO3 Sig Rnge	+ AO3 Sig Rnge
		ANTEROOM PRESSURE (PRESSURE TRANSDUCER; SENSOR MIN=0)			0	AO3 Sig Rnge
		SUPPLY FLOW			0	AO3 Sig Rnge
		EXHAUST FLOW			0	AO3 Sig Rnge
					NOTICE	
If Cntrl Device is set to EXHAUST/SUPPLY/TEMP , the AO3 Sig Rnge item will not be accessible. DO NOT set AO3 Sig Rnge to a value greater than the sensor input.						

Diagnostics Menu

MENU ITEM	SOFTWARE NAME	ITEM DESCRIPTION
View Measurement Inputs	View Inputs	The View Inputs item allows the user to view the measurements for all 7 inputs on one screen.
View Output Signals	View Outputs	<p>The View Outputs item allows the user to view the current output signals, in units of V or mA.</p> <p style="text-align: center;">NOTICE</p> <p>Use the Flow Control or Temp Control items to manually control the output signals.</p>
Control Relay Outputs	Relay Outputs	The Relay Outputs item allows the user to view and manually control the 2 relay outputs.
Manually Control Flows	Flow Control	<p>The Flow Control item allows the user to manually control the supply and exhaust flow control devices while seeing how they affect the flow and room pressure measurements.</p> <p style="text-align: center;">NOTICE</p> <p>The RPC30 will not maintain room pressure differential, minimum ventilation or temperature control while the Flow Control item is active.</p>
Manually Control Temperature	Temp Control	<p>The Temp Control item allows the user to manually control the supply flow and temperature control devices while seeing how they affect the flow and temperature measurements.</p> <p style="text-align: center;">NOTICE</p> <p>The RPC30 will not maintain room pressure differential, minimum ventilation or temperature control while the Temp Control item is active.</p>
Manually Adjust Analog Outputs	Analog Outpt	The Analog Outpt item allows the user to manually control the Analog Outputs.
Recalibrate Touchscreen	Touch Cal	<p>The Touch Cal item starts the touchscreen recalibration process. While recalibrating the touchscreen, the PresSura™ controller will direct the user to touch the screen in various places.</p> <p style="text-align: center;">NOTICE</p> <p>Recalibrating the touchscreen is best accomplished using a stylus, pen, or similar object.</p>
Reset to Default	Reset	The Reset item resets all parameters to factory default.

Input1 Config Menu

TSI® Sensor

MENU ITEM	SOFTWARE NAME	ITEM DESCRIPTION	ITEM RANGE	DEFAULT VALUE
Set Sensor Zero Calibration	Sensor Zero	The Sensor Zero item is used to re-zero the TSI Sensor zero calibration point.	None	Unit is factory calibrated and should not need adjustment.
Set Sensor Span Calibration	Sensor Span	The Sensor Span item is used to match or calibrate the PresSura™ controller TSI® sensor to the average room pressure velocity as measured by a portable air velocity meter.	None	Unit is factory calibrated and should not need adjustment.
Set Sensor Elevation	Elevation	<p>The Elevation item is used to enter the elevation of the sensor above sea level. This item has a range of 0 to 10,000 feet in 1,000 foot increments. The pressure value needs to be corrected due to changes in air density at different elevations.</p> <p>While this number can be entered in increments of 1 foot, the density adjustments are in 1,000 foot increments. For example, if the PresSura™ controller will interpret Elevation settings between 0 and 999 feet as 0 feet, settings between 1000 and 1999 feet as 1000 feet, etc.</p>	0 to 10,000 feet above sea level	0
Reset Calibration	Reset Cal	The Reset Cal item is used to return to the factory default calibration, undoing field calibration adjustments. When this menu item is entered, the controller will prompt the user to verify that they want to do this by displaying the message "Are You Sure." Entering YES resets the Sensor Zero , Sensor Span and Elevation items to defaults. Entering NO will cancel the reset.	None	N/A

Input1 Config Menu

TSI® Sensor

MENU ITEM	SOFTWARE NAME	ITEM DESCRIPTION	ITEM RANGE	DEFAULT VALUE	
Check Sensor Status	Check Status	The Check Status item is used to check the communication status of the sensor. After pressing the button, the PresSura™ unit will respond with:	None	N/A	
		COMM ERROR			DIM cannot communicate with sensor. Check all wiring and the pressure sensor address.
		SENS ERROR			Physical damage to pressure sensor circuitry. Unit IS NOT field-repairable. Send to TSI® for repair.
		CAL ERROR			Calibration data lost. Send to TSI® for calibration.
		DATA ERROR			Problem with sensor EEPROM, field calibration or analog output. Check all data configured and confirm unit is functioning correctly.

Input1 Config Menu

Press Trans

MENU ITEM	SOFTWARE NAME	ITEM DESCRIPTION	ITEM RANGE	DEFAULT VALUE
Set Minimum Sensor Pressure Output	Sensor Min	The Sensor Min item is used to set the minimum reading of a pressure transducer used to measure room pressure differential. For example, if the pressure transducer has a range of -0.25 in. W.C. to +0.25 in. W.C. (-62.5 to +62.5 Pa), the Sensor Min should be set to -0.25 in. W.C. (-62.5 Pa).	-1.00 to +1.00 in. W.C.	0
Set Maximum Sensor Pressure Output	Sensor Max	The Sensor Max item is used to set the maximum reading of a pressure transducer used to measure room pressure differential. For example, if the pressure transducer has a range of -0.25 in. W.C. to +0.25 in. W.C. (-62.5 to +62.5 Pa), the Sensor Max should be set to +0.25 in. W.C. (+62.5 Pa).	-1.00 to +1.00 in. W.C.	0
Set Minimum Sensor Voltage Output	Signal Min	The Signal Min item is used to set the minimum output signal when a pressure transducer is used to measure room pressure differential.	0 to 5 V	0 V
Set Maximum Sensor Voltage Output	Signal Max	The Signal Max item is used to set the maximum output signal when a pressure transducer is used to measure room pressure differential.	1 to 10 V	10 V
Set Sensor Zero Calibration	Sensor Zero	The Sensor Zero item is used to re-zero the pressure transducer zero calibration point.	None	N/A
Reset Calibration	Reset Cal	The Reset Cal item is used to return to the factory default calibration, undoing any field calibration adjustments. When this menu item is entered, the controller will prompt the user to verify that they want to do this by displaying the message "Are You Sure." Entering YES resets the Sensor Zero factor for this sensor to defaults. Entering NO will cancel the reset.	None	N/A

Input2 Config Menu

TSI® Sensor

MENU ITEM	SOFTWARE NAME	ITEM DESCRIPTION	ITEM RANGE	DEFAULT VALUE
Set Sensor Zero Calibration	Sensor Zero	The Sensor Zero item is used to re-zero the TSI® Sensor zero calibration point.	None	Unit is factory calibrated and should not need adjustment.
Set Sensor Span Calibration	Sensor Span	The Sensor Span item is used to match or calibrate the PresSura™ TSI® sensor to the average room pressure velocity as measured by a portable air velocity meter.	None	Unit is factory calibrated and should not need adjustment.
Set Sensor Elevation	Elevation	<p>The Elevation item is used to enter the elevation of the sensor above sea level. This item has a range of 0 to 10,000 feet in 1,000 foot increments. The pressure value needs to be corrected due to changes in air density at different elevations.</p> <p>While this number can be entered in increments of 1 foot, the density adjustments are in 1,000 foot increments. For example, if the PresSura™ controller will interpret Elevation settings between 0 and 999 feet as 0 feet, settings between 1000 and 1999 feet as 1000 feet, etc.</p>	0 to 10,000 feet above sea level	0
Reset Calibration	Reset Cal	The Reset Cal item is used to return to the factory default calibration, undoing field calibration adjustments. When this menu item is entered, the controller will prompt the user to verify that they want to do this by displaying the message "Are You Sure." Entering YES resets the Sensor Zero , Sensor Span and Elevation items to defaults. Entering NO will cancel the reset.	None	N/A

Input2 Config Menu

TSI® Sensor

MENU ITEM	SOFTWARE NAME	ITEM DESCRIPTION	ITEM RANGE	DEFAULT VALUE	
Check Sensor Status	Check Status	<p>The Check Status item is used to check the communication status of the sensor. After pressing the button, the PresSura™ unit will respond with:</p>	None	N/A	
		<p>COMM ERROR</p>			<p>DIM cannot communicate with sensor. Check all wiring and the pressure sensor address.</p>
		<p>SENS ERROR</p>			<p>Physical damage to pressure sensor circuitry. Unit IS NOT field-repairable. Send to TSI® for repair.</p>
		<p>CAL ERROR</p>			<p>Calibration data lost. Send to TSI® for calibration.</p>
		<p>DATA ERROR</p>			<p>Problem with sensor EEPROM, field calibration or analog output. Check all data configured and confirm unit is functioning correctly.</p>

Input2 Config Menu

Press Trans

MENU ITEM	SOFTWARE NAME	ITEM DESCRIPTION	ITEM RANGE	DEFAULT VALUE
Set Minimum Sensor Pressure Output	Sensor Min	The Sensor Min item is used to set the minimum reading of a pressure transducer used to measure room pressure differential. For example, if the pressure transducer has a range of -0.25 in. W.C. to +0.25 in. W.C. (-62.5 to +62.5 Pa), the Sensor Min should be set to -0.25 in. W.C. (-62.5 Pa).	-1.00 to +1.00 in. W.C.	0
Set Maximum Sensor Pressure Output	Sensor Max	The Sensor Max item is used to set the maximum reading of a pressure transducer used to measure room pressure differential. For example, if the pressure transducer has a range of -0.25 in. W.C. to +0.25 in. W.C. (-62.5 to +62.5 Pa), the Sensor Max should be set to +0.25 in. W.C. (+62.5 Pa).	-1.00 to +1.00 in. W.C.	0
Set Minimum Sensor Voltage Output	Signal Min	The Signal Min item is used to set the minimum output signal when a pressure transducer is used to measure room pressure differential.	0 to 5 V	0 V
Set Maximum Sensor Voltage Output	Signal Max	The Signal Max item is used to set the maximum output signal when a pressure transducer is used to measure room pressure differential.	1 to 10 V	10 V
Set Sensor Zero Calibration	Sensor Zero	The Sensor Zero item is used to re-zero the pressure transducer zero calibration point.	None	N/A
Reset Calibration	Reset Cal	The Reset Cal item is used to return to the factory default calibration, undoing any field calibration adjustments. When this menu item is entered, the controller will prompt the user to verify that they want to do this by displaying the message "Are You Sure." Entering YES resets the Sensor Zero factor for this sensor to defaults. Entering NO will cancel the reset.	None	N/A

Input2 Config Menu

Temp Setpnt

MENU ITEM	SOFTWARE NAME	ITEM DESCRIPTION	ITEM RANGE	DEFAULT VALUE
Set Minimum Temperature Adjustment	Sensor Min	The Sensor Min item is used to set the minimum reading of the thermostat. For example, if the temperature adjustment of the thermostat is from -5° to +5°, the Sensor Min should be set to -5.	-10°F to 0°F	-5°F
Set Maximum Temperature Adjustment	Sensor Max	The Sensor Max item is used to set the maximum reading of the thermostat. For example, if the temperature adjustment of the thermostat is from -5° to +5°, the Sensor Max should be set to 5.	0°F to 10°F	5°F
Set Minimum Sensor Voltage Output	Signal Min	The Signal Min item is used to set the minimum output signal from the thermostat setpoint adjustment.	0 to 10 V	0 V
Set Maximum Sensor Voltage Output	Signal Max	The Signal Max item is used to set the maximum output signal from the thermostat setpoint adjustment.	1 to 10 V	10 V
Reset Calibration	Reset Cal	The Reset Cal item is used to return to the factory default calibration, undoing any field calibration adjustments. When this menu item is entered, the controller will prompt the user to verify that they want to do this by displaying the message "Are You Sure." Entering YES resets the Sensor Min , Sensor Max , Signal Min and Signal Max factors for this sensor to defaults. Entering NO will cancel the reset.	None	N/A

Input3 Config Menu

Sup Pres Flow

MENU ITEM	SOFTWARE NAME	ITEM DESCRIPTION	ITEM RANGE	DEFAULT VALUE
Set Flow Station Duct Area	Duct Area	<p>The Duct Area item is used to program the cross sectional area of the duct where the flow station is mounted. Since the flow station is used to measure duct velocity, the Duct Area is necessary to calculate the duct air flow.</p> <p style="text-align: center;">NOTICE</p> <p>The DIM DOES NOT compute duct area. The area must be first calculated and then entered into the unit.</p> <p>Use the following equations to calculate the duct area (in ft²).</p> <p>For round ducts</p> $\text{Duct Area} = \frac{3.14 * \left[\frac{\text{duct diameter (in inches)}}{2} \right]^2}{144}$ <p>For rectangular ducts</p> $\text{Duct Area} = \frac{[\text{width (in inches)} * \text{height (in inches)}]}{144}$ <p style="text-align: center;">WARNING</p> <p>If the proper Duct Area is not programmed into the Model RPC30, the flow measurement will be incorrect. Thus, all the other information that uses the flow measurement, such as the flow alarms, will also be incorrect.</p>	0 to 50.00 ft ² (0 to 4.6450 m ²)	0.00 ft ² (0.0000 m ²)
Set Flow K-Factor Adjustment	K-Factor	<p>The K-Factor menu item sets the “K” factor for the flow signal. The flow signal is multiplied by the K-Factor so that the flow measurement matches the actual flow, determined with a pitot tube traverse or other reference measurement.</p> <p style="text-align: center;">NOTICE</p> <p>K-Factor modifies the entire range of the calibrated flow, not just a single point.</p>	0.01 to 10.00	1.00

Input3 Config Menu

Sup Pres Flow

MENU ITEM	SOFTWARE NAME	ITEM DESCRIPTION	ITEM RANGE	DEFAULT VALUE
Set Flow Station Zero Calibration	Sensor Zero	The Sensor Zero item is used to re-zero the pressure transducer zero calibration point.	NONE	
Set Maximum Sensor Pressure Output	Sensor Max	The Sensor Max item is used to set the maximum reading of a flow station and pressure transducer used to measure supply air flow. For example, if the pressure transducer has a range of 0 in. W.C. to +0.25 in. W.C. (0 to +62.5 Pa), the Sensor Max should be set to +0.25 in. W.C. (+62.5 Pa).	-1.00 to + 1.00 in. W.C.	1.00 in. W.C.
Set Minimum Sensor Voltage Output	Signal Min	The Signal Min item is used to set the minimum output signal when a flow station and pressure transducer is used to supply flow.	0 to 10 V	0 V
Set Maximum Sensor Voltage Output	Signal Max	The Signal Max item is used to set the maximum output signal when a flow station and pressure transducer is used to measure supply flow.	1 to 10 V	10 V
Flow Station Low Calibration	Low Cal	The Low Cal menu item enters the LOW CAL Submenu.	See Flow Calibration	
Flow Station High Calibration	High Cal	The High Cal menu item enters the HI CAL Submenu.	See Flow Calibration	
Reset Calibration	Reset Cal	The Reset Cal item is used to return to the factory default calibration, undoing any field calibration adjustments. When this menu item is entered, the controller will prompt the user to verify that they want to do this by displaying the message "Are You Sure." Entering YES resets the Low Cal , High Cal and K-Factor factors for this sensor to defaults. Entering NO will cancel the reset.	None	N/A

Input3 Config Menu

Sup Lin Flow

MENU ITEM	SOFTWARE NAME	ITEM DESCRIPTION	ITEM RANGE	DEFAULT VALUE
Set Flow Station Duct Area	Duct Area	<p>The Duct Area item is used to program the cross sectional area of the duct where the flow station is mounted. Since the flow station is used to measure duct velocity, the Duct Area is necessary to calculate the duct air flow.</p> <p style="text-align: center;">NOTICE</p> <p>The DIM DOES NOT compute duct area. The area must be first calculated and then entered into the unit.</p> <p>Use the following equations to calculate the duct area (in ft²).</p> <p>For round ducts</p> $\text{Duct Area} = \frac{3.14 * \left[\frac{\text{duct diameter (in inches)}}{2} \right]^2}{144}$ <p>For rectangular ducts</p> $\text{Duct Area} = \frac{[\text{width (in inches)} * \text{height (in inches)}]}{144}$ <p style="text-align: center;">WARNING</p> <p>If the proper Duct Area is not programmed into the Model RPC30, the flow measurement will be incorrect. Thus, all the other information that uses the flow measurement, such as the flow alarms, will also be incorrect.</p>	0 to 50.00 ft ² (0 to 4.6450 m ²)	0.00 ft ² (0.0000 m ²)
Set Flow K-Factor Adjustment	K-Factor	<p>The K-Factor menu item sets the “K” factor for the flow signal. The flow signal is multiplied by the K-Factor so that the flow measurement matches the actual flow, determined with a pitot tube traverse or other reference measurement.</p> <p style="text-align: center;">NOTICE</p> <p>K-Factor modifies the entire range of the calibrated flow, not just a single point.</p>	0.01 to 10.00	1.00

Input3 Config Menu

Sup Lin Flow

MENU ITEM	SOFTWARE NAME	ITEM DESCRIPTION	ITEM RANGE	DEFAULT VALUE
Set Maximum Sensor Output	Sensor Max	The Sensor Max item is used to set the maximum reading of a flow station used to measure supply air flow. The Sensor Max item has increments of 1000 ft/min.	0 to 10,000 ft/min	0
Set Minimum Sensor Voltage Output	Signal Min	The Signal Min item is used to set the minimum output signal when a flow station and pressure transducer is used to supply air flow.	0 to 10 V	0 V
Set Maximum Sensor Voltage Output	Signal Max	The Signal Max item is used to set the maximum output signal when a flow station and pressure transducer is used to supply air flow.	1 to 10 V	10 V
Reset Calibration	Reset Cal	The Reset Cal item is used to return to the factory default calibration, undoing any field calibration adjustments. When this menu item is entered, the controller will prompt the user to verify that they want to do this by displaying the message "Are You Sure." Entering YES resets the K Factor for this sensor to defaults. Entering NO will cancel the reset.	None	N/A

Input3 Config Menu

Sup Venturi

MENU ITEM	SOFTWARE NAME	ITEM DESCRIPTION	ITEM RANGE	DEFAULT VALUE
Minimum Flow	Min Flow	<p>The Min Flow item sets the flow rate through the venturi valve when it is fully closed. The display will indicate a volumetric flow rate. Adjust the displayed value to match the flow through the venturi valve.</p> <p style="text-align: center;">NOTICE</p> <p>The flow information can be obtained from the label on the TSI® Venturi Valve or by closing the venturi valve using the Flow Control item in the DIAGNOSTICS menu and performing a pitot tube traverse of the duct.</p> <p>The Min Flow menu item must be completed before moving on to the Max Flow menu item.</p>	0 to 10000 cfm	0 cfm
Maximum Flow	Max Flow	<p>The Max Flow item sets the flow rate through the venturi valve when it is fully open. The display will indicate a volumetric flow rate. Adjust the displayed value to match the flow through the venturi valve.</p> <p style="text-align: center;">NOTICE</p> <p>The flow information can be obtained from the label on the TSI® Venturi Valve or by opening the venturi valve using the Flow Control item in the DIAGNOSTICS menu and performing a pitot tube traverse of the duct.</p> <p>The Min Flow menu item must be completed before moving on to the Max Flow menu item.</p>	0 to 10000 cfm	0 cfm
Set Flow K-Factor Adjustment	K-Factor	<p>The K-Factor menu item sets the “K” factor for the flow signal. The flow signal is multiplied by the K-Factor so that the flow measurement matches the actual flow, determined with a pitot tube traverse or other reference measurement.</p> <p style="text-align: center;">NOTICE</p> <p>K-Factor modifies the entire range of the calibrated flow, not just a single point.</p>	0.01 to 10.00	1.00

Input3 Config Menu

Sup Venturi

MENU ITEM	SOFTWARE NAME	ITEM DESCRIPTION	ITEM RANGE	DEFAULT VALUE
Reset Calibration	Reset Cal	The Reset Cal item is used to return to the factory default calibration, undoing any field calibration adjustments. When this menu item is entered, the controller will prompt the user to verify that they want to do this by displaying the message "Are You Sure." Entering YES resets the K-Factor factor for this sensor to defaults. Entering NO will cancel the reset.	None	N/A

Input3 Config Menu

Supply Switch

MENU ITEM	SOFTWARE NAME	ITEM DESCRIPTION	ITEM RANGE	DEFAULT VALUE
Low Flow Alarm Signal	Low Flow Sig	The Low Flow Sig item sets the signal the Model RPC30 Room Pressure Controller will receive to indicate a low supply flow condition when a sail, or other flow-proving, switch is installed.	Open, Closed	Closed

Input4 Config Menu

Rm1 Dr Sw

MENU ITEM	SOFTWARE NAME	ITEM DESCRIPTION	ITEM RANGE	DEFAULT VALUE
Signal to Indicate Open Door	Dr Open Sig	The Dr Open Sig item sets the signal the Model RPC30 Room Pressure Controller will receive to indicate a door is open.	Open, Closed	Closed
Control Delay when Closing Door	Freeze Delay	The Freeze Delay item sets the period of time the RPC30 Room Pressure Controller will wait to begin modulating dampers to control room pressure differential after the door is closed.	0 to 120 seconds	0 seconds

Input4 Config Menu

Rm1 Occ Sen

MENU ITEM	SOFTWARE NAME	ITEM DESCRIPTION	ITEM RANGE	DEFAULT VALUE
Room Unoccupied Signal	Unocc Sig	The Unocc Sig item is used to set the signal that indicates the room is unoccupied.	Open, Closed	Closed

Input5 Config Menu

Rm1 Key Switch

ITEM DESCRIPTION
The Model RPC30 will display a message “Nothing to Configure” when Input 5 is set to Rm1 Key Switch and the user enters the Input5 Config menu.

Input5 Config Menu

RH

MENU ITEM	SOFTWARE NAME	ITEM DESCRIPTION	ITEM RANGE	DEFAULT VALUE
Set Minimum Sensor Output	Sensor Min	The Sensor Min item is used to set the minimum reading of the relative humidity sensor.	0 to 100% RH	0% RH
Set Maximum Sensor Output	Sensor Max	The Sensor Max item is used to set the maximum reading of the relative humidity sensor.	0 to 100% RH	100% RH
Set Minimum Sensor Voltage Output	Signal Min	The Signal Min item is used to set the minimum output signal of the relative humidity sensor.	0 to 10 V	0 V
Set Maximum Sensor Voltage Output	Signal Max	The Signal Max item is used to set the maximum output signal of the relative humidity sensor.	1 to 10 V	10 V
Adjust Sensor Calibration	Sensor Span	The Sensor Span item is used to adjust the calibration of the relative humidity sensor. The Sensor Span is an offset adjustment and can only be adjusted by $\pm 10\%$ RH.	-10% to +10% RH	0% RH

Input5 Config Menu

RH

MENU ITEM	SOFTWARE NAME	ITEM DESCRIPTION	ITEM RANGE	DEFAULT VALUE
Reset Calibration	Reset Cal	The Reset Cal item is used to return to the factory default calibration, undoing any field calibration adjustments. When this menu item is entered, the controller will prompt the user to verify that they want to do this by displaying the message "Are You Sure." Entering YES resets the Sensor Span factor for this sensor to defaults. Entering NO will cancel the reset.	None	N/A

Input6 Config Menu

Rm1 Temp

MENU ITEM	SOFTWARE NAME	ITEM DESCRIPTION	ITEM RANGE	DEFAULT VALUE
Adjust Sensor Calibration	Sensor Span	The Sensor Span item is used to adjust the calibration of the room temperature sensor. The Sensor Span is an offset adjustment and can only be adjusted by $\pm 10^{\circ}\text{F}$.	-10°F to +10°F	0°F
Reset Calibration	Reset Cal	The Reset Cal item is used to return to the factory default calibration, undoing any field calibration adjustments. When this menu item is entered, the controller will prompt the user to verify that they want to do this by displaying the message "Are You Sure." Entering YES resets the Sensor Span factor for this sensor to defaults. Entering NO will cancel the reset.	None	N/A

Input6 Config Menu

Ant Occ Sen

MENU ITEM	SOFTWARE NAME	ITEM DESCRIPTION	ITEM RANGE	DEFAULT VALUE
Signal to Indicate Room Unoccupied	Unocc Sig	The Unocc Sig item is used to set the signal that indicates the room is unoccupied.	Open, Closed	Closed

Input6 Config Menu

Ante Dr Sw

MENU ITEM	SOFTWARE NAME	ITEM DESCRIPTION	ITEM RANGE	DEFAULT VALUE
Signal to Indicate Open Door	Dr Open Sig	The Dr Open Sig item sets the signal the Model RPC30 Room Pressure Controller will receive to indicate a door is open.	Open, Closed	Closed

Input7 Config Menu

Rm1 Sup Tmp

MENU ITEM	SOFTWARE NAME	ITEM DESCRIPTION	ITEM RANGE	DEFAULT VALUE
Adjust Sensor Calibration	Sensor Span	The Sensor Span item is used to adjust the calibration of the supply air temperature sensor. The Sensor Span is an offset adjustment and can only be adjusted by $\pm 10^{\circ}\text{F}$.	-10°F to $+10^{\circ}\text{F}$	0°F
Reset Calibration	Reset Cal	The Reset Cal item is used to return to the factory default calibration, undoing any field calibration adjustments. When this menu item is entered, the controller will prompt the user to verify that they want to do this by displaying the message "Are You Sure." Entering YES resets the Sensor Span factor for this sensor to defaults. Entering NO will cancel the reset.	None	N/A

(continued on next page)

Input7 Config Menu

Exh Pres Flow

MENU ITEM	SOFTWARE NAME	ITEM DESCRIPTION	ITEM RANGE	DEFAULT VALUE
Set Flow Station Duct Area	Duct Area	<p>The Duct Area item is used to program the cross sectional area of the duct where the flow station is mounted. Since the flow station is used to measure duct velocity, the Duct Area is necessary to calculate the duct air flow.</p> <div style="border: 1px solid black; background-color: #0056b3; color: white; text-align: center; padding: 2px;">NOTICE</div> <p>The DIM DOES NOT compute duct area. The area must be first calculated and then entered into the unit.</p> <p>Use the following equations to calculate the duct area (in ft²).</p> <p>For round ducts</p> $Duct\ Area = \frac{3.14 * \left[\frac{duct\ diameter\ (in\ inches)}{2} \right]^2}{144}$ <p>For rectangular ducts</p> $Duct\ Area = \frac{width\ (in\ inches) * height\ (in\ inches)}{144}$ <div style="background-color: #ff9900; text-align: center; padding: 2px;">WARNING</div> <p> If the proper Duct Area is not programmed into the Model RPC30, the flow measurement will be incorrect. Thus, all the other information that uses the flow measurement, such as the flow alarms, will also be incorrect.</p>	0 to 50.00 ft ² (0 to 4.6450 m ²)	0.00 ft ² (0.0000 m ²)
Set Flow K-Factor Adjustment	K-Factor	<p>The K-Factor menu item sets the “K” factor for the flow signal. The flow signal is multiplied by the K-Factor so that the flow measurement matches the actual flow, determined with a pitot tube traverse or other reference measurement.</p> <div style="border: 1px solid black; background-color: #0056b3; color: white; text-align: center; padding: 2px;">NOTICE</div> <p>K-Factor modifies the entire range of the calibrated flow, not just a single point.</p>	0.01 to 10.00	1.00
Set Flow Station Zero Calibration	Sensor Zero	The Sensor Zero item is used to re-zero the pressure transducer zero calibration point.	NONE	N/A

Input7 Config Menu

Exh Pres Flow

MENU ITEM	SOFTWARE NAME	ITEM DESCRIPTION	ITEM RANGE	DEFAULT VALUE
Set Maximum Sensor Pressure Output	Sensor Max	The Sensor Max item is used to set the maximum reading of a flow station and pressure transducer used to measure exhaust air flow. For example, if the pressure transducer has a range of 0 in. W.C. to +0.25 in. W.C. (0 to +62.5 Pa), the Sensor Max should be set to +0.25 in. W.C. (+62.5 Pa).	0 to + 1.00 in. W.C.	1.00 in. W.C.
Set Minimum Sensor Voltage Output	Signal Min	The Signal Min item is used to set the minimum output signal when a flow station and pressure transducer is used to measure exhaust flow	0 to 10 V	0 V
Set Maximum Sensor Voltage Output	Signal Max	The Signal Max item is used to set the maximum output signal when a flow station and pressure transducer is used to measure exhaust flow.	1 to 10 V	10 V
Flow Station Low Calibration	Low Cal	The Low Cal menu item enters the LOW CAL Submenu.	See Flow Calibration	
Flow Station High Calibration	High Cal	The High Cal menu item enters the HI CAL Submenu.	See Flow Calibration	
Reset Calibration	Reset Cal	The Reset Cal item is used to return to the factory default calibration, undoing any field calibration adjustments. When this menu item is entered, the controller will prompt the user to verify that they want to do this by displaying the message "Are You Sure." Entering YES resets the Low Cal , High Cal and K-Factor factors for this sensor to defaults. Entering NO will cancel the reset.	None	N/A

Input7 Config Menu

Exh Lin Flow

MENU ITEM	SOFTWARE NAME	ITEM DESCRIPTION	ITEM RANGE	DEFAULT VALUE
Set Flow Station Duct Area	Duct Area	<p>The Duct Area item is used to program the cross sectional area of the duct where the flow station is mounted. Since the flow station is used to measure duct velocity, the Duct Area is necessary to calculate the duct air flow.</p> <div style="border: 1px solid black; background-color: #0056b3; color: white; text-align: center; padding: 2px;">NOTICE</div> <p>The DIM DOES NOT compute duct area. The area must be first calculated and then entered into the unit.</p> <p>Use the following equations to calculate the duct area (in ft²).</p> <p>For round ducts</p> $Duct\ Area = \frac{3.14 * \left[\frac{duct\ diameter\ (in\ inches)}{2} \right]^2}{144}$ <p>For rectangular ducts</p> $Duct\ Area = \frac{[width\ (in\ inches) * height\ (in\ inches)]}{144}$ <div style="border: 1px solid black; background-color: #ff9900; text-align: center; padding: 2px;">WARNING</div> <p> If the proper Duct Area is not programmed into the Model RPC30, the flow measurement will be incorrect. Thus, all the other information that uses the flow measurement, such as the flow alarms, will also be incorrect.</p>	0 to 50.00 ft ² (0 to 4.6450 m ²)	0.00 ft ² (0.0000 m ²)
Set Flow K-Factor Adjustment	K-Factor	<p>The K-Factor menu item sets the “K” factor for the flow signal. The flow signal is multiplied by the K-Factor so that the flow measurement matches the actual flow, determined with a pitot tube traverse or other reference measurement.</p> <div style="border: 1px solid black; background-color: #0056b3; color: white; text-align: center; padding: 2px;">NOTICE</div> <p>K-Factor modifies the entire range of the calibrated flow, not just a single point.</p>	0.01 to 10.00	1.00

Input7 Config Menu

Exh Lin Flow

MENU ITEM	SOFTWARE NAME	ITEM DESCRIPTION	ITEM RANGE	DEFAULT VALUE
Set Maximum Sensor Output	Sensor Max	The Sensor Max item is used to set the maximum reading of a flow station used to measure exhaust air flow. The Sensor Max item has increments of 1000 ft/min.	0 to 10,000 ft/min	0
Set Minimum Sensor Voltage Output	Signal Min	The Signal Min item is used to set the minimum output signal when a flow station and pressure transducer is used to measure exhaust air flow	0 to 10 V	0 V
Set Maximum Sensor Voltage Output	Signal Max	The Signal Max item is used to set the maximum output signal when a flow station and pressure transducer is used to measure exhaust air flow.	1 to 10 V	10 V
Reset Calibration	Reset Cal	The Reset Cal item is used to return to the factory default calibration, undoing any field calibration adjustments. When this menu item is entered, the controller will prompt the user to verify that they want to do this by displaying the message "Are You Sure." Entering YES resets the K-Factor factor for this sensor to defaults. Entering NO will cancel the reset.	None	N/A

Input7 Config Menu

Exh Venturi

MENU ITEM	SOFTWARE NAME	ITEM DESCRIPTION	ITEM RANGE	DEFAULT VALUE
Minimum Flow	Min Flow	<p>The Min Flow item sets the flow rate through the venturi valve when it is fully closed. The display will indicate a volumetric flow rate. Adjust the displayed value to match the flow through the venturi valve.</p> <div style="border: 1px solid black; padding: 5px; margin: 10px 0;"> <p style="text-align: center;">NOTICE</p> <p>The flow information can be obtained from the label on the TSI® Venturi Valve or by closing the venturi valve using the Flow Control item in the DIAGNOSTICS menu and performing a pitot tube traverse of the duct.</p> </div> <p>The Min Flow menu item must be completed before moving on to the Max Flow menu item.</p>	0 to 10000 cfm	0 cfm

Input7 Config Menu

Exh Venturi

MENU ITEM	SOFTWARE NAME	ITEM DESCRIPTION	ITEM RANGE	DEFAULT VALUE
Maximum Flow	Max Flow	<p>The Max Flow item sets the flow rate through the venturi valve when it is fully open. The display will indicate a volumetric flow rate. Adjust the displayed value to match the flow through the venturi valve.</p> <p style="text-align: center;">NOTICE</p> <p>The flow information can be obtained from the label on the TSI® Venturi Valve or by opening the venturi valve using the Flow Control item in the DIAGNOSTICS menu and performing a pitot tube traverse of the duct.</p> <p>The Min Flow menu item must be completed before moving on to the Max Flow menu item.</p>	0 to 10000 cfm	0 cfm
Set Flow K-Factor Adjustment	K-Factor	<p>The K-Factor menu item sets the “K” factor for the flow signal. The flow signal is multiplied by the K-Factor so that the flow measurement matches the actual flow, determined with a pitot tube traverse or other reference measurement.</p> <p style="text-align: center;">NOTICE</p> <p>K-Factor modifies the entire range of the calibrated flow, not just a single point.</p>	0.01 to 10.00	1.00
Reset Calibration	Reset Cal	<p>The Reset Cal item is used to return to the factory default calibration, undoing any field calibration adjustments. When this menu item is entered, the controller will prompt the user to verify that they want to do this by displaying the message “Are You Sure.” Entering YES resets the K-Factor factor for this sensor to defaults. Entering NO will cancel the reset.</p>	None	N/A

Input7 Config Menu

Exh Switch

MENU ITEM	SOFTWARE NAME	ITEM DESCRIPTION	ITEM RANGE	DEFAULT VALUE
Low Flow alarm Signal	Low Flow Sig	The Low Flow Sig item sets the signal the Model RPC30 Room Pressure Controller will receive to indicate a low exhaust flow condition.	Open, Closed	Close

Input7 Config Menu

Ante Key Switch

ITEM DESCRIPTION
The Model RPC30 will display a message "Nothing to Configure" when Input 5 is set to Ante Key Switch and the user enters the Input5 Config menu.

Calibration

The calibration section explains how to calibrate the controller and how to zero a TSI® flow station pressure transducer (optional). The Model RPC30 controller will warn the user with a display message if it has not been calibrated.

NOTICE

This section assumes that the appropriate sensor has been correctly installed. Inaccurate readings may be detected if sensor is not installed correctly. Review the Installation Instructions and verify that the sensor is installed correctly (usually only a problem on initial set up).

Reference measurements, such as from a Portable Air Velocity Meter like TSI® Incorporated's VelociCalc® Model 9565 or a capture hood like the Alnor® Balometer® Model EBT731, are required to calibrate the PresSura™ controllers.



WARNING

The controller is disabled during calibration. Alarms will not function to warn of unsafe conditions.

To begin the calibration process, enter the appropriate **INPUT# CONFIGURE** menu (see [Software Programming](#) if not familiar with keystroke procedure).

Room Pressure Calibration

Room pressure can be measured using either a TSI® through-the-wall sensor or a pressure transducer.

TSI® (Through-the-Wall) Sensor Calibration

NOTICE

The TSI® through-the-wall sensor is calibrated at the factory and does not normally need adjustment when installed.

1. Select **SENSOR SPAN** item.
2. Position a thermal anemometer or other instrument configured to measure air velocity in the door opening to obtain a velocity reading. Take a measurement of the air velocity entering/exiting the door.
3. Input the reference measurement from step 3 into the PresSura™ controller.
4. Save the reading and exit the menu system.

Pressure Transducer Calibration

NOTICE

This calibration process is to configure the PresSura™ controller to match the reading from the pressure transducer. If the pressure transducer itself needs to be calibrated, refer to the instructions that come with the pressure transducer.

1. Write down the output signal range and pressure range of the pressure transducer. As an example for these instructions, we will assume the pressure transducer has an output signal range of 0 to 10 V and a pressure range of -0.25 to +0.25 in. W.C.
2. Select the **SENSOR MIN** item and enter the minimum pressure range of the transducer. In this example, you would enter -0.25 in. W.C.

3. Select the **SENSOR MAX** item and enter the maximum pressure range of the transducer. In this example, you would enter +0.25 in. W.C.
4. Select the **SIGNAL MIN** item and enter the minimum output signal of the transducer. In this example, you would enter 0 V.
5. Select the **SIGNAL MAX** item and enter the maximum output signal of the transducer. In this example, you would enter 10 V.
6. To zero the pressure transducer:
 - a. Mark the high pressure tubing going to the high port of the transducer.
 - b. Remove the tubing from the high and low ports of the transducer.
 - c. Enter the **SENSOR ZERO** item on the PresSura™ controller.
 - d. Reconnect tubing to the high and low ports of the pressure transducer, using the mark to connect the high pressure tubing to the high port.

Flow Calibration

Flow can be measured using a Pressure Flow Station, Linear Flow Station or Venturi with feedback.

Pressure Flow Station Calibration

NOTICE

Flow stations are optional and may not be installed in your system.

1. Set **DUCT AREA** item to the duct area where the flow is measured.
2. To Zero the flow station:
 - a. Mark the high pressure tubing going to the high port of the transducer.
 - b. Remove the tubing from the high and low ports of the transducer.
 - c. Enter the **SENSOR ZERO** item on the PresSura™ controller.
 - d. Reconnect tubing to the high and low ports of the pressure transducer, using the mark to connect the high pressure tubing to the high port.
3. Enter the **LOW CAL** item to perform the low flow calibration submenu with the following items:

LOW POS	Damper position for low flow calibration
ZERO VOLTAGE	Voltage from pressure transducer during Flow Station Pressure Transducer Zero
VOLTAGE INPUT	Current voltage from pressure transducer
ZERO VOLTAGE	Voltage from pressure transducer during Flow Station Pressure Transducer Zero
CALIBRATED FLOW	Input actual flow as measured with reference instrument here

- a. With the **LOW POS** at 0% (default), observe the **VOLTAGE INPUT** displayed on the screen, or use a voltmeter to read the voltage at the pressure input terminals on the back of the controller.
- b. Slowly increase the **LOW POS** percentage value to adjust the damper position until the **VOLTAGE INPUT** (pressure transducer output) shows the first noticeable increase in

voltage from the 0% position. A general rule-of-thumb is that the voltage change should occur with the damper between approximately 10% to 30% open.

- c. For reference only, the **UNCALIBRATED FLOW** item will display the default measured flow based on the current settings of the flow station (duct area, etc.).
 - d. Determine the actual flow with a duct traverse.
 - e. Enter the actual flow measurement under the **CALIBRATED FLOW** menu item.
 - f. Press the **SAVE** key to save the flow data.
 - g. The low flow calibration is complete.
4. Enter the **HIGH CAL** item to perform the high flow calibration submenu with the following items:

HIGH POS	Damper position for high flow calibration
ZERO VOLTAGE	Voltage from pressure transducer during Flow Station Pressure Transducer Zero
VOLTAGE INPUT	Current voltage from pressure transducer
ZERO VOLTAGE	Voltage from pressure transducer during Flow Station Pressure Transducer Zero
CALIBRATED FLOW	Input actual flow as measured with reference instrument here

- a. With the **HIGH POS** at 100% (default), observe the **VOLTAGE INPUT** displayed on the screen, or use a voltmeter to read the voltage at the pressure input terminals on the back of the controller.
- b. Slowly decrease the **HIGH POS** percentage value to adjust the damper position until the **VOLTAGE INPUT** (pressure transducer output) shows the first noticeable decrease in voltage from the 100% position. A general rule-of-thumb is that the voltage change should occur with the damper between approximately 70% to 80% open.
- c. For reference only, the **UNCALIBRATED FLOW** item will display the default measured flow based on the current settings of the flow station (duct area, etc.).
- d. Determine the actual flow with a duct traverse.
- e. Enter the actual flow measurement under the **CALIBRATED FLOW** menu item.
- f. Press the **SAVE** key to save the flow data.
- g. The low flow calibration is complete.

NOTICE

Use **BALANCE MODE** to verify flow station calibration and adjust the **K-FACTOR**.

Linear Flow Station Calibration

NOTICE

Flow stations are optional and may not be installed in your system.

1. Set **DUCT AREA** to the duct area at the linear flow station location.
2. Set **SENSOR MAX** to match the range of the linear flow station used.
3. Set **SIGNAL MIN** to match the minimum voltage output (0 to 10 V) of the linear flow station used. This is typically 0 V.

4. Set **SIGNAL MAX** to match the maximum voltage output (0 to 10 V) of the linear flow station used. This is typically 10 V.
5. Linear flow station calibration should be complete. Exit the menu.

NOTICE

Use **BALANCE MODE** to verify flow station calibration and adjust the **K-FACTOR**.

Venturi with Feedback Calibration

NOTICE

LOM Venturi Valves are optional and may not be installed in your system

1. Obtain the venturi valve minimum and maximum flow, either by reading the label on the venturi valve or by performing duct traverses when the venturi valve is fully closed and fully opened.
2. Set **MIN FLOW** to the minimum venturi valve flow.
3. Set **MAX FLOW** to the maximum venturi valve flow.
4. Venturi with Feedback calibration is now complete. Exit the menu.

NOTICE

Use **BALANCE MODE** to verify Venturi with Feedback calibration and adjust the **K-FACTOR**.

Supply/Exhaust Switch Calibration



NOTICE

Flow switches are optional and may not be installed in your system.
Flow switches do not actually measure the flow, but are designed to provide an open or closed signal to indicate the presence or absence of flow.

1. Set the **LOW FLOW SIGNAL** to match the low flow indication from the switch. **OPEN** means the switch will open to indicate low flow. **CLOSED** means the switch will close to indicate low flow.

Door Switch Configuration



NOTICE

Door switches are optional and may not be installed in your system.

1. Set the **DR OPEN SIGNAL** to match the door open indication from the switch. **OPEN** means the switch will open to indicate the door is open. **CLOSED** means the switch will close to indicate the door is open.

Temperature Sensor Configuration



NOTICE

Temperature sensors are optional and may not be installed in your system.

1. Adjust the **SENSOR SPAN** so the displayed temperature matches a reference measurement. Use the **RESET CAL** item to reset the **SENSOR SPAN** back to the factory default.

Relative Humidity Sensor Configuration



NOTICE

Relative Humidity sensors are optional and may not be installed in your system.

1. Set the **SENSOR OUT MIN** to the minimum reading of the relative humidity sensor. This is usually 0%.
2. Set the **SENSOR OUT MAX** to the maximum reading of the relative humidity sensor. This is usually 100%.
3. Set the **SENSOR SIG MIN** to the minimum output voltage of the relative humidity sensor. This is usually 0 V.
4. Set the **SENSOR SIG MAX** to the maximum output voltage of the relative humidity sensor. This is usually 10 V.
5. Adjust the **SENSOR SPAN** so the displayed relative humidity matches a reference measurement.

Use the **RESET CAL** item to reset the **SENSOR SPAN** back to the factory default.

Occupancy Sensor Configuration



NOTICE

Occupancy switches are optional and may not be installed in your system.

1. Set the **ROOM UNOCC SIG** to match the occupancy indication from the switch. **OPEN** means the switch will open to indicate the room is unoccupied. **CLOSED** means the switch will close to indicate the room is unoccupied.

Supply Air Temperature Sensor Configuration



NOTICE

Supply Air Temperature sensors are optional and may not be installed in your system.

Supply air temperature sensors may be part of the room temperature control. However, a room temperature sensor is also required.

1. Adjust the **SENSOR SPAN** so the displayed temperature matches a reference measurement.

Use the **RESET CAL** item to reset the **SENSOR SPAN** back to the factory default.

Optimizing Controller Performance

The Model RPC30 controller uses both integral and PI control methods. Integral control (slower control signal) is used when the controller is near set point. Integral control provides stability when natural system fluctuations occur such as duct static pressure variation. PI control (fast control) is used when responding to large disturbances to room pressure differential. PI control rapidly returns the room pressure differential to set point, thus assuring containment. Once the controller is in PI control, it continues to control in this mode until the operating set point is met.

There are four menu items that change the characteristics of the control output signal;

- 1) SENSITIVITY
- 2) SPEED
- 3) Kc VALUE
- 4) Ti VALUE

TSI® Incorporated recommends only adjusting the **SENSITIVITY** and **SPEED** to fine tune the control signal. Only when the **SPEED** and **SENSITIVITY** items cannot provide a stable system should **Exh Kc Value**, **Sup Kc Value**, **Exh Ti Value** and **Sup Ti Value** be adjusted. The role of each menu item is covered in the [Menu and Menu Items](#) section of the manual. This section provides some guidance of when a menu item should be changed.

The controller is shipped with PI values that are appropriate for most rooms. If adjustment is needed, minor changes to the **SENSITIVITY** and **SPEED** menu items will yield excellent control. The **SENSITIVITY** item selects when the unit goes into PI control. Each percent of the setting from 100% indicates that the controller must be 1 ft/min away from control set point prior to activating PI control. If the **SENSITIVITY** setting is 60% (40% missing), the room pressure (velocity) must be 40 ft/min off set point before PI control is activated. Conversely, if the **SENSITIVITY** setting is 80% (20% missing), the room pressure (velocity) must only be 20 ft/min off set point before PI control is activated. The default of 80% is usually a good compromise between PID and integral control.

The **SPEED** menu item slows down the control output. The controller is shipped with a control signal capable of rotating the damper 90 degrees in 1.5 seconds. This may be too fast if the damper is in an unstable flow area (very near the exhaust fan), or there are competing air flows at the room. Controllers modulating a VFD system will probably need to be slowed down, since the control signal is substantially faster than the VFD/fan can respond.

The remaining menu items, **Exh Kc Value**, **Sup Kc Value**, **Exh Ti Value** and **Sup Ti Value** should not be adjusted unless severe stability problems exist. Adjusting these variables may improve the response and stability, but the exact opposite may happen causing the controller to become unstable, hunt substantially, or have very slow response. If controller performance cannot be improved by adjusting the **SPEED** and **SENSITIVITY**, the two menu items can be manually set to their default values.

Maintenance and Repair Parts

The Model RPC30 PresSura™ Room Pressure Controller requires minimal maintenance. Periodic inspections of system components as well as an occasional pressure sensor cleaning are all that are needed to ensure that the PresSura™ controller is operating properly.

System Component Inspection

It is recommended that the pressure sensor be periodically inspected for accumulation of contaminants. The frequency of these inspections is dependent upon the quality of the air being drawn across the sensor. Quite simply, if the air is dirty, the sensors require more frequent inspection and cleaning.

Visually inspect the pressure sensor by sliding open the sensor housing door (Figure 12). The air flow orifice should be free of obstructions. The small ceramic coated sensors protruding from the orifice wall should be white and free of accumulated debris.

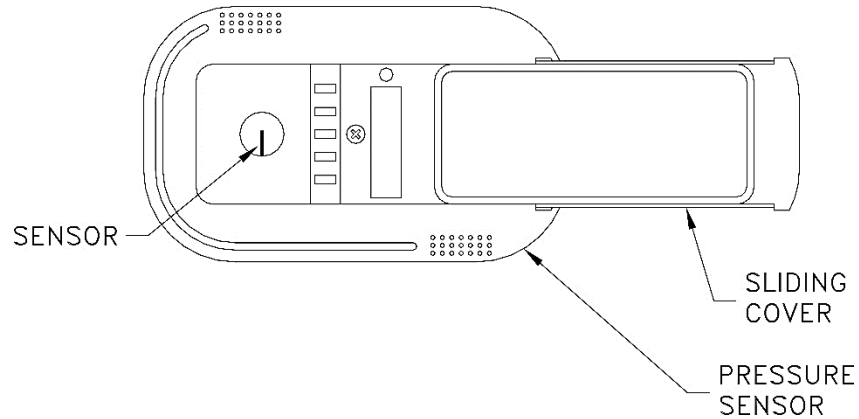



Figure 12: Pressure sensor door slid open

Periodically inspect the other system components for proper performance and physical signs of excessive wear.

Pressure Sensor Cleaning

Accumulations of dust or dirt can be removed with a dry soft-bristled brush (such as an artist's brush). If necessary, water, alcohol, acetone, or trichlorethane may be used as a solvent to remove other contaminants.

Use extreme care when cleaning the velocity sensors. The ceramic sensor may break if excessive pressure is applied, if sensor is scraped to remove contaminants, or if the cleaning apparatus abruptly impacts the sensor.

	WARNING
<p>If you are using a liquid to clean the sensor, turn off power to the RPC30 PresSura™ Controller.</p> <p>DO NOT use compressed air to clean the velocity sensors.</p> <p>DO NOT attempt to scrape contaminants from the velocity sensors. The velocity sensors are quite durable; however, scraping may cause mechanical damage and possibly break the sensor. Mechanical damage due to scraping voids the pressure sensor warranty.</p>	

Display Screen Cleaning

Accumulations of dust or dirt can be removed with a dry soft cloth. If necessary, Isopropyl, or Ethyl Alcohol may be used to remove other contaminants.

Replacement Parts

All components of the Room Pressure Control system are field replaceable. Contact TSI® or your nearest TSI® Manufacturer's Representative for replacement part pricing and delivery.

Part Number	Description
Found on back of unit	Model RPC30 PresSura™ Room Pressure Controller
800243	Pressure Sensor
800248	Sensor Cable
800414	Transformer Cable
800199	Controller Output Cable
800380	Electric Actuator

Troubleshooting Section

The Model RPC30 Room Pressure Controller is designed to be trouble free. However, installation problems or interaction with other HVAC components may cause system problems. The system is easy to troubleshoot if an organized approach to evaluate the system is taken. Troubleshooting is broken down into hardware (mechanical) and software problems. Hardware problems deal with the physical installation of the device. Hardware problems include wiring problems, incorrectly installed equipment, and add-ons or non-TSI® equipment. Software problems include control problems, configuration problems, or interaction problems with the HVAC system.

The hardware test described in this section determines that all TSI® mechanical components are functioning correctly. The hardware test requires the diagnostics menu items to be accessed. If you are unfamiliar with the controller menus, see [Software Programming](#) for keystroke procedure. Troubleshooting the majority of problems is usually quick if the hardware test is followed.

Software and hardware problems are covered in the troubleshooting chart. Pick the problem that most closely resembles your problem and review the possible symptoms and corrective action. Software or system performance problems can and are affected by the supply air system, exhaust air system, or physical configuration of the room. Separating TSI® system problems from the laboratory HVAC system can sometimes be difficult. TSI® recommends confirming all hardware is operating correctly before troubleshooting software problems.

Hardware Test

Three tests need to be performed in order to determine all hardware is functioning correctly. The tests are broken down into:

- Confirming wiring is correct.
- Confirming physical installation is correct.
- Verifying mechanical components.

Confirming wiring is correct

The most common problem with installed hardware equipment is incorrect wiring. This problem usually exists on initial installation, or when modifications to the system take place. The wiring should be very closely checked to verify it **exactly** matches the wiring diagram. Wiring diagrams are located in [Appendix C](#) of this manual. Wiring associated with non-TSI components should be closely checked for correct installation. If non-TSI components are installed, consider disconnecting them for testing purposes.

Confirming physical installation is correct

All of the hardware components need to be installed properly. Review the installation instructions and verify components are installed properly at the correct location. This is easily done when the wiring is checked.

Verifying mechanical components

Verifying all TSI® components are operating correctly requires following a simple procedure. The fastest procedure to confirm all equipment is operating is to first test the Digital Interface Module (DIM), and then go into the diagnostic menu to test each component.



NOTICE

These tests require power to the units, so if unit has no power, refer to hardware troubleshooting chart to eliminate power problem.

Enter Diagnostics menu and check the following:

- Flow Control
- Temperature Control
- Analog Outputs
- Relay Outputs
- View Inputs
- View Outputs

Test - Flow Control

Enter the **Flow Control** item in the Diagnostics menu to manually manipulate the supply and exhaust flows.



The RPC30 will not maintain room pressure differential, flow rates or temperature control while in the Flow Control item.

- Touch the **Exhaust** button to manually command the exhaust control device to a new position.
 - If the RPC30 is not configured for Exhaust Control, the Exhaust button will display Bad Interface. AO1 Signal Type.
- Touch the **Supply** button to manually command the supply control device to a new position.
 - If the RPC30 is not configured for Supply Control, the Supply button will display Bad Interface. AO2 Signal Type.

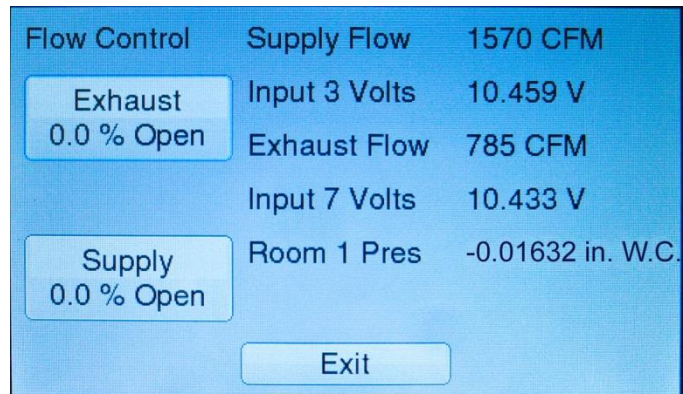

Figure 13. Flow Control screen in Diagnostics menu

- Supply flow, Supply input, Exhaust flow, Exhaust input and Room 1 Pres measurements will update in real time.
 - The Model RPC30 controller will display “Not configured” for any measurements that have not been configured. Go to the **Configure** menu to set up the appropriate input.

Test - Temp Control

Enter the **Temp Control** item in the Diagnostics menu to manually manipulate the supply and exhaust flows.



The RPC30 will not maintain room pressure differential, flow rates or temperature control while in the Temp Control item.

- Touch the **Temp** button to manually command the temperature control device to a new position.
 - If the RPC30 is not configured for Temp Control, the Temp button will display Bad Interface. AO3 Signal Type.
- Touch the **Supply** button to manually command the supply control device to a new position.
 - If the RPC30 is not configured for Supply Control, the Supply button will display Bad Interface. AO2 Signal Type.

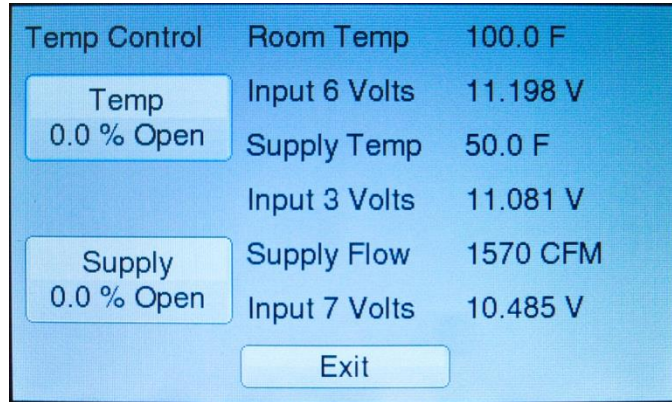

Figure 14. Temp Control screen in Diagnostics menu

- Room Temp, Supply Temp and Supply Flow measurements and input voltages will update in real time.
 - The Model RPC30 controller will display “Not configured” for any measurements that have not been configured. Go to the **Configure** menu to set up the appropriate input.

Test – Analog Outputs

Enter the **Analog Output** item in the Diagnostics menu to manually manipulate the analog outputs.

- Touch the **Output 1**, **Output 2**, **Output 3** button to manually set the output signal.

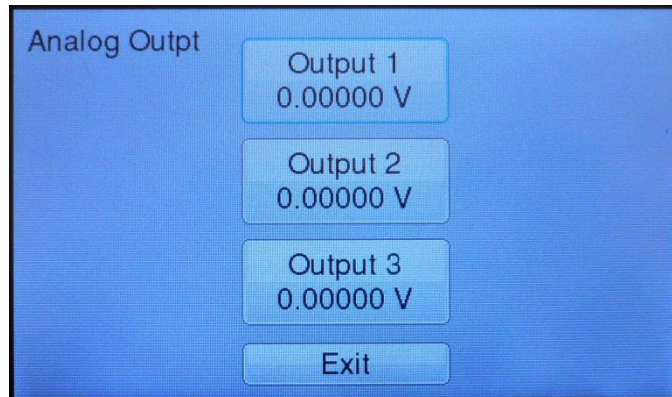

Figure 15. Analog Outputs screen in Diagnostics menu

Test – Relay Outputs

Enter the **Relay Outputs** item in the Diagnostics menu to manually manipulate the relay outputs.

- Touch the **Relay 1 Toggle** or **Relay 2 Toggle** button to manually open or close the relay.



Figure 16. Relay Outputs screen in Diagnostics menu

Test - View Inputs

Enter the **View Inputs** item to view all inputs with real-time updates.

- The Model RPC30 controller will display “Unconfigured” for any inputs that have not been configured. Go to the **Configure** menu to configure these inputs appropriately.
- Use the Flow Control or Temp Control items to manipulate control outputs and view how measurements respond.

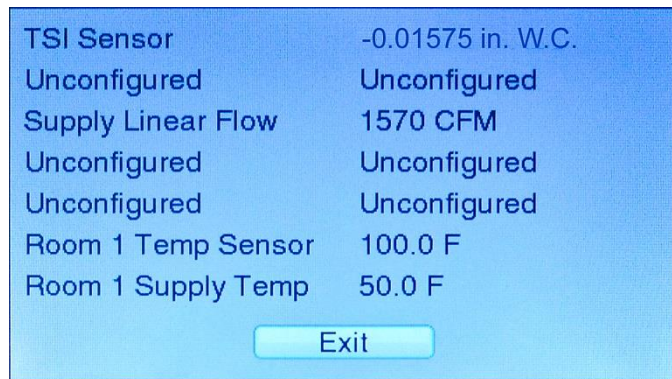

Figure 17. View Inputs screen in Diagnostics menu

Test - View Outputs

Enter the **View Outputs** item to view all output signals with real-time updates.

- Use the Flow Control or Temp Control items to manipulate control outputs and view how measurements respond.

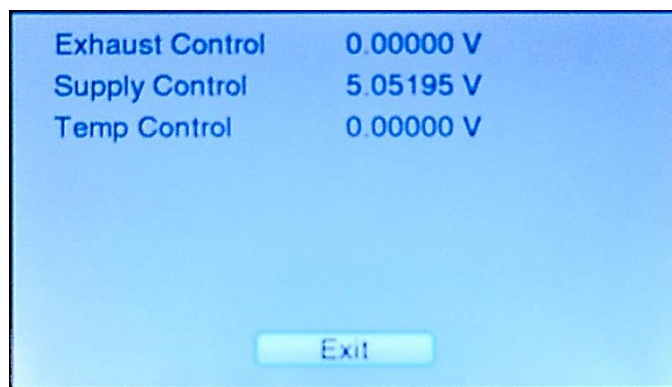

Figure 18. View Outputs screen in Diagnostics menu

If the controller passes each of the tests, the mechanical piece parts are all functioning correctly.

Test – Touch Cal

If the touch screen does not properly register the position of touches, enter the Touch Cal item to recalibrate the touch screen. When recalibrating the touch screen, the PresSura™ controller will prompt the user to touch the screen in the top left and bottom right corner.



Use a stylus or similar instrument for best calibration of the touch screen.

Troubleshooting Chart

Symptom	Possible Cause	Corrective Action
Display is blank.	Fuse is blown.	<p>Measure voltage at pins 1 and 2 on DIM 2-pin connector. The voltage should nominally be:</p> <ul style="list-style-type: none"> 15 to 40 VDC when powered from a TSI® electric actuators. 24 to 30 VAC when powered from a transformer. <p>If correct voltage is measured, internal DIM fuse is probably blown. Unplug 2-pin connector from DIM for 2 minutes. The internal fuse will automatically reset. Plug unit back in and check display. If display is still blank, check all wiring, etc.</p> <p>If approximately 5 volts is measured, the fuse in the electric actuator is blown. Disconnect power to the electric actuator for two minutes to reset fuse. Disconnecting power requires either shutting off circuit breaker or disconnecting the wires on pins 1 and 2 on the electric actuator.</p> <p>If zero volts are measured, see No power to DIM.</p> <p>Verify circuit breaker is on. Verify transformer primary measures 110 VAC. Verify transformer secondary measures 24 to 30 VAC. <i>If using DC power output from TSI® electric actuator:</i> Verify electric actuator is receiving 24 to 30 VAC between pins 1 and 2. Verify 15 to 40 VDC is found between pins 3 and 4 of the electric actuator.</p>
	No power to DIM.	<p>Verify circuit breaker is on. Verify transformer primary measures 110 VAC. Verify transformer secondary measures 24 to 30 VAC. Verify 15 to 40 VDC is found between pins 3 and 4 of the electric actuator (if powered from a TSI® electric actuator) Verify DIM voltage on pins 1 and 2 is 24 to 30 VAC (if powered from a transformer), or 15 to 40 VDC (if powered from a TSI® electric actuator).</p>
	DIM is defective.	<p>If proper voltage is found between pins 1 and 2 of the DIM, all wiring has been checked, fuses have been reset, and screen is still blank, the DIM is probably defective. Replace DIM.</p>
Cannot access menu.		Slide finger across the screen diagonally from upper right to lower left corner.

Symptom	Possible Cause	Corrective Action
Need to display model number and firmware revision.	--	Enter the DIAGNOSTICS menu.
Measurements in Diagnostics mode read "Not Configure."	Inputs not configured.	Enter the Configure menu to appropriately configure inputs.
Controller is not controlling.	Incorrect wiring.	Verify correct wiring (see Wiring diagram ; Appendix C). DIM must be wired exactly as shown.
	DIM is in no isolation mode.	If in no isolation mode, damper goes to preset position, flow control or pressure control. See Rm1 Setpnts menu No Iso Type and No Iso Setpnt items.
	Damper/Valve moving opposite direction.	If damper is full open when it should be closed or full closed when it should be open, go into Control menu Exh Cntl Dir and Sup Cntl Dir menu items. Change DIRECT to REVERSE or REVERSE to DIRECT to change control output direction.
	No control output signal.	Go into Diagnostics menu, Flow Control item. The RPC30 controller will show the supply and exhaust control outputs as a number between 0% Open and 100% Open. Measure the exhaust or supply control output voltage. Touch the Supply or Exhaust button to input a new control output, changing the value by about 40% Open. The control output voltage should change approximately 4 VDC. Change the control output value to 50% open; the control output voltage should read approximately 5 VDC. If no change to the control voltage output occurs, disconnect the control wires and repeat the test. If DIM still fails to change voltage output, DIM is probably defective. If voltage changed DIM is working, and either wiring or actuator (VFD) needs to be examined.

Symptom	Possible Cause	Corrective Action
Controller is not controlling. (cont.)	Bad actuator or valve (damper or valve linkage does not move).	Go into Diagnostics menu, Flow Control item. The RPC30 controller will show the supply and exhaust control outputs as a number between 0% Open and 100% Open. Change the control output value to 0% Open and note the damper/valve position. Then change the control output value to 100% Open. The damper should have rotated 45° or 90° depending on the actuator settings or the valve linkage moved full stroke. If damper/valve did not move, check that: <ul style="list-style-type: none"> • Damper/valve is not physically stuck (screws, etc.). • Wiring is correct between actuators and controller. Check that voltage varies between 0 and 10 volts on pins 5 and 6 on electric actuator (see No control output signal). Electric actuator is not over torqued. The electric actuator has current limiting protection. If damper is physically stuck or actuator is over current, the actuator will shut down. To restart either cycle power to actuator or move damper/valve in opposite direction (Flow Control menu item).
	Defective variable frequency drive (VFD).	Perform test described in Control system is not controlling . If Flow Control is functioning, verify wiring to VFD by confirming control output voltage changes at VFD. If voltage changes, a problem with VFD exists. See VFD manual for further troubleshooting.
	Damper/Valve is full open or full closed, won't move.	Control wires are loose. Check wires and verify control output is working (see No control output signal). If control output test passes, verify damper/valve is moving in correct direction (see Damper/Valve moving opposite direction). If damper/valve is moving correctly and set point cannot be reached, DIM will fully move damper/valve to get as close to set point as possible. Exhaust; fan, static pressure, etc. needs to be adjusted.
Sensor does not calibrate.	Incorrect pressure sensor address.	Rm1 pressure sensor must have address of 1. Anteroom sensor must have address of 2. Check pressure sensor DIP switches 1 & 2 and verify address is correct (7 to 12 must be OFF). <div style="text-align: center;"> <p>Figure 19: Pressure sensor DIP switch</p> </div>

Symptom	Possible Cause	Corrective Action
Sensor does not calibrate. (cont.)	Sensor communications not working.	Check SENSOR STAT item in diagnostics menu. If NORMAL is displayed, sensor is okay. If COMM ERROR is displayed, check wiring, pressure sensor address, and that DIP switch 1 & 2 are ON (Figure 19).
Pressure sensor red LED is blinking (Figure 19).	Problem with sensor (slow uniform blink).	Check SENSOR STAT and confirm NORMAL is displayed. If ERROR is displayed, correct error.
	Communication (fast burst of non-uniform blinking).	Unit is communicating with DIM. This is normal.
	Red LED is constantly on or blinks every 5 seconds.	This is normal when no problems exist or when no communication is occurring.
DIM always displays 0.200 in. W.C.	Incorrect pressure sensor output.	Pressure sensor must be set for 0 to 10 volt output, not 4-20 mA (DO NOT confuse this output with DIM analog output). Check pressure sensor DIP switch 3 and make sure it is OFF (see Figure 19).
DIM displays opposite pressure signal.	Sensor direction is incorrect.	Pressure sensor must have DIP switch correctly set for proper sign display. Verify DIP switch 4 is ON when sensor is mounted in isolation room (controlled space), and OFF when sensor is mounted in reference space (see Figure 19).
Positive/negative/neutral key switch does not work.	Incorrect wiring.	Verify wiring is correct between key switch and DIM.
	Inputs not configured for key switch	Go to Configure menu, Input 5 item (for Room 1 key switch) or Input 7 item (for AnteRoom key switch). Verify item is set to Room 1 Key Switch or AnteRoom Key Switch.
	Defective switch / defective DIM.	Verify Rm1 Alarm or Anterm Alm menu, ROOM MODE item is set to KEYSWITCH . Go into DIAGNOSTICS menu, VIEW INPUTS item. Key Switch inputs should read negative in negative position, positive in positive position, and no isolation in neutral position. If display changes correctly, switch and switch input is good. If display does not change: Disconnect key switch wires from Input 4, pins 17 & 18 for Room 1, or Input 7, pins 23 and 24 for Anteroom. Measure the resistance of the switch: <ul style="list-style-type: none"> Negative position should be open (infinite). Neutral position should read approximately 273 kOhms. Positive position should be closed (short). If room mode is correct and resistance check is good, DIM key input is probably defective. Replace DIM.

Symptom	Possible Cause	Corrective Action
DIM does not respond to network communications.	Network protocol is incorrect.	Go into INTERFACE menu, COMM TYPE item. The protocol must match host system. Select correct interface.
	Incorrect network address.	The network address at the building automation system and at the DIM must match. The network address must be unique for each DIM.
	Incorrect MAC ID (BACnet® MS/TP only)	The MAC ID and network address at the building automation system and at the DIM must match. The MAC ID and network ADDRESS must be unique for each DIM.
	Incorrect baud rate (BACnet® MS/TP only)	The baud rate of the building automation system and the DIM must match. Reset the BAUD RATE item in the Interface menu to match the building automation system.
	Incorrect polarity.	Verify and/or change polarity of RS-485 A and B wires.
	Incompatible software.	Data sent to DIM may be in form that the controller cannot recognize.
	LonWorks® board not installed.	Contact factory for further assistance.
	Bad LonWorks® board.	Contact factory for assistance.
	Foreign network acquired controller. (LonWorks® only)	Go into Interface menu, LON item. Select GO UNCONFIG option, press the SELECT key. Return to the LON item, select the SERVICE PIN option and press the SELECT key. Selecting GO UNCONFIG will reset the PresSura™ controller's authentication key, allowing the SERVICE PIN to install or reclaim the PresSura™ controller to the LonWorks® network.
Alarm relays do not work.	Alarms are turned off.	Enter the Rm1 Alarm or AnteRm Alarm menu. Verify that the Alarm Enable item is set to enable the high or low alarms as desired.
	Incorrect wiring.	Check the wiring from DIM relay output to the device that is connected to the relays.
	Relay may be defective.	Disconnect the wiring (terminals 9 to 12) from relay contacts. Go into DIAGNOSTICS menu, RELAY OUTPUTS item. Connect an ohm-meter to relay terminals to verify contact open and closes. Press the Relay1 Toggle or Relay 2 Toggle button to manually trip the relay. <ul style="list-style-type: none"> • If relay responds (contact opens and closes), the device connected is incompatible or defective. • If relay does not respond, relay is defective (may be caused by incompatible device). Replace DIM.
Actuator hunting. Display indicates steady velocity.	Control system is unstable.	Go into CONTROL menu, SPEED item. Turn speed down until hunting is eliminated. If speed is too slow, adjust accordingly to eliminate problem.

Symptom	Possible Cause	Corrective Action
Displayed room pressure or flow wildly fluctuating.	Supply or Exhaust system unstable.	Go to DIAGNOSTICS menu, FLOW CONTROL item to take manual control of the supply and exhaust control devices. If room pressure stabilizes, supply or exhaust system is not stable. Verify reference pressure is stable.
	Supply air is affecting the sensor.	Check location of supply air diffusers. They should be located as far from the pressure sensor as is realistic, 10 feet preferred with 6 feet minimum. Supply diffuser terminal throw velocity must be less than 10 ft/min at the sensor. Relocate supply or exhaust as needed.
	Display averaging is very short.	Lengthen the time constant by entering the CONFIGURE menu, DISPLAY AVG item, and increase the average time.
	Controller needs calibration.	Calibrate controller.
Analog output does not work properly.	Controller is connected to incompatible equipment.	Enter the DIAGNOSTICS menu, Temp Control item. Use the TEMP button to adjust Analog Output 3 and the Supply button to adjust Analog Output 2. Change the output value while measuring the output with a multimeter. If the voltage (current) changes, the controller is functioning properly. If the voltage (current) does not change, disconnect the analog out device and repeat the above procedure. If voltage now changes, the controller is good, and the external device is defective. If no change occurs, DIM is defective.
Displayed velocity does not match measured velocity.	Pressure sensor is dirty.	See Maintenance and Repair Parts .
	Controller is not calibrated.	See Calibration .
"LON OVERRIDE ON" on the display	BAS Communications have taken control of RPC30. 	Release control at BMS to clear.
		WARNING
		Adequate room pressure differential may not be maintained while LON overrides the control signal.
Monitor does not communicate with TSI® Configuration Software	Defective cable	Replace cable with TSI® P/N 700036.

Symptom	Possible Cause	Corrective Action
Audible alarm is sounding intermittently	Configuration settings lost (single beep every 2 seconds)	Replace controller.
	Calibration settings lost (double beep every 2 seconds)	Replace controller.
	Configuration and calibration settings lost (double beep every second)	Replace controller.

Appendix A

Specifications*

Digital Interface Module	
Display	
Range	-0.20000 to +0.20000 in. W.C. (-50 to +50 Pa): TSI® Sensor -1.00 to +1.00 in. W.C. (-250 to +250 Pa): Pressure Transducer
Annual Drift	0.0%
Accuracy Drift	±10% of reading ±0.00001 in. H ₂ O (±0.0025 Pa)
Resolution	5% of reading or 0.00001.0 in. W.C. (0.0025 Pa): TSI® Sensor 5% of reading or 0.001.0 in. W.C. (0.25 Pa): Pressure Transducer
Low Alarm Range	-0.19500 to +0.19500 in. W.C.: TSI® Sensor -1.00 to +1.00 in. W.C. (-249 to +249 Pa): Pressure Transducer 0 to 10,000 cfm (0 to 4,720 l/s, 0 to 16,990 m ³ /hr.)
High Alarm Range	80 to 1,000 ft/min (0.41 to 5.08 m/s) 0 to 10,000 cfm (0 to 4,720 l/s, 0 to 16,990 m ³ /hr.)
Communications Protocols...	Modbus® RTU 9600 baud BACnet® MS/TP 76.8k, 38.4k, 19.2k, 9600 baud LonWorks® (Optional)
Operating Temperature	32 to 120°F (0 to 50°C)
Input Power.....	24 VAC, 50/60 Hz 15 to 40 VDC 5 Watt maximum (50 VA with TSI® Actuator)
Dimensions	7.0 in x 4.875 in x 1.75 in (17.8 cm x 12.4 cm x 4.4 cm) 0.625 in (1.6 cm) protrusion
Weight.....	14 oz. (0.40 kg)
Velocity Sensor	
Inputs—Seven (7) Total	
Input 1	TSI® Sensor or Pressure Transducer (0 to 10 VDC)
Input 2	TSI Sensor, Pressure Transducer or Temperature Setpoint (0 to 10 VDC)
Input 3	Supply Flow (0 to 10 VDC)
Input 4	Door Switch or Occupancy Sensor (Relay In)
Input 5	Room 1 Key Switch (Relay In) or RH (0 to 10 VDC)
Input 6	Anteroom Door Switch or Occupancy Sensor (Relay In) Room 1 Temperature (1000 Ω Platinum RTD)
Input 7	Anteroom Key Switch (Relay In) Exhaust Flow (0 to 10 VDC) Supply Air Temperature (1000 Ω Platinum RTD)

Outputs–Three (3)Total	
Output 1	Exhaust Control (0 to 10 VDC)
Output 2	Supply Control (0 to 10 VDC) Room 1 Pressure Out, Exhaust Flow Out (0 to 10 VDC / 4-20 mA)
Output 3	Temperature Control (0 to 10 VDC / 4-20 mA) Anteroom Pressure Out, Exhaust Flow Out, Supply Flow Out (0 to 10 VDC / 4-20 mA)
Alarm Contacts	Relay1: Low Alarm Relay 2: High Alarm or Room Mode SPST, 60 W max 2A @ 30 VDC Nominal Contacts field-configurable to open or close in alarm condition. Contacts close on loss of power.
TSI® Through-the-Wall Sensor	
Temperature Compensation Range	55 to 95°F
Power Dissipation	0.16 watts at 0 in. W.C., 0.20 watts at 0.00088 in. W.C.
Dimensions (D x H)	5.58 in. x 3.34 in. x 1.94 in. (84.8 x 141.7 x 49.3 mm)
Weight.....	0.2 lb.
Damper/Actuator	
Types of Actuator	Electric
Input Power.....	Electric: 24 VAC, 50 VA max
Time for 90° Rotation.....	1.5 sec.

**Specifications are subject to change without notice.*

Appendix B

Network Communications

Network communications are available on the PresSura™ room controllers. The PresSura™ room controllers can communicate with a building management system through Modbus®, LonWorks® or BACnet® MS/TP protocols. Please refer to the appropriate section below for more detailed information.

Modbus® Communications

Modbus® communications are installed in the PresSura™ room controllers. This document provides the technical information needed to communicate between the host DDC system and the PresSura room controllers. This document assumes the programmer is familiar with Modbus® protocol. Further technical assistance is available from TSI® if your question is related to TSI interfacing to a DDC system. If you need further information regarding Modbus® programming in general, please contact:

Modicon Incorporated (a division of Schneider-Electric)
One High Street
North Andover, MA 01845
Phone (800) 468-5342

The Modbus® protocol utilizes the RTU format for data transfer and Error Checking. Check the Modicon Modbus® Protocol Reference Guide (PI-Mbus-300) for more information on CRC generation and message structures.

The messages are sent at 9600 baud with 1 start bit, 8 data bits, and 1 or 2 stop bits. **DO NOT** use the parity bit. The system is set up as a master slave network. The TSI units act as slaves and respond to messages when their correct address is polled.

Blocks of data can be read from each device. Using a block format will speed up the time for the data transfer. The size of the blocks is limited to 255 bytes. This means the maximum message length that can be transferred is 255 bytes. The typical response time of the device is around 0.05 seconds with a maximum of 0.1 seconds.

Unique to TSI®

The list of variable addresses shown below skips some numbers in the sequence due to internal PresSura™ room controller functions. This information is not useful to the DDC system and is therefore deleted. Skipping numbers in the sequence will not cause any communication problems. If a variable is not used by the particular PresSura™ room controllers, it will be reported with a value of -1.

All variables are outputted in English units: ft/min, and cfm. If the DDC system is to display different units, the DDC system needs to make the conversion.

Network Points RAM Variables

RAM variables use the Modbus® command **04 Read Input Registers**. RAM variables are read only variables that correspond to what is shown on Digital Interface Module (DIM) display. TSI® offers a number of different models, so if a feature is not available on a unit, the variable is set to 0.

Variable Name	Variable Address	Information Provided to Master System	Integer DDC system receives
Room 1 Pressure	0	Room 1 Pressure	Displayed in in. W.C. Host DDC system must divide value by 10,000 to report pressure correctly
Supply Flow	1	Supply Flow Rate	Displayed in CFM.
ACH	2	Air Changes per Hour	Displayed in number per hour. Host DDC system must divide value by 10 to report ACH correctly.
RH	3	Relative Humidity	Displayed in %RH
Temperature	4	Temperature for Room 1	Displayed in °F Host DDC system must divide value by 10 to report temperature correctly
Exhaust Flow	6	Exhaust Flow Rate	Displayed in CFM.
Room 1 Door Status	7	Room 1 Door Status	1 Door Closed (Normal) 2 Door Open
Anteroom Pressure	8	Anteroom Pressure	Displayed in in. W.C. Host DDC system must divide value by 100,000 to report pressure correctly
Anteroom Door Status	9	Anteroom Door Status	1 Door Closed (Normal) 2 Door Open
Supply Air Discharge Temperature	11	Room 1 Supply Air Discharge Temperature	Displayed in °F Host DDC system must divide value by 10 to report temperature correctly
Room 1 Occupancy	13	Room 1 Occupancy	1 Occupied (Normal) 2 Unoccupied
Anteroom Occupancy	14	Anteroom Occupancy	1 Occupied (Normal) 2 Unoccupied

EXAMPLE of **04 Read Input Registers** function format
This example reads variable addresses 0 (Pressure).

QUERY

Field Name	Example # 2 (Hex)
Slave Address	01
Function	04
Starting Address Hi	00
Starting Address Lo	00
No. of Points Hi	00
No. of Points Lo	01
Error Check (CRC)	--

RESPONSE

Field Name	Example # 1 (Hex)
Slave Address	01
Function	04
Byte Count	02
Data Hi Addr0	00
Data Lo Addr0	64 (0.00100 "H ₂ O)

Modbus Communications (continued)

XRAM Variables

These variables can be *read* using Modbus® command **03 Read Holding Registers**. They can be *written* to using Modbus® command **06 Write Single Register**. Many of these variables are the same “menu items” that are configured from the controller keypad. The calibration and control items are not accessible from the DDC system. This is for safety reasons since each room is individually setup for maximum performance.

RPC30 Variable List

Variable Name	Variable Address	Read/Write	Integer DDC system receives
Number of Rooms	0	Read	1 1 Room 2 1 Room with Anteroom
Devices Controlled	1	Read	1 None 2 Exhaust 3 Exhaust / Supply / Temp
Measurements Displayed	2	Read/Write	1 Room Status 2 Room Status and Pressure 3 All Measurements
Display Average	3	Read	1 1 second 2 2 seconds 3 3 seconds 4 5 seconds 5 10 seconds 6 20 seconds 7 40 seconds
Units	4	Read/Write	1 in. W.C., cfm, F 2 Pa, lps, C 3 Pa, m ³ /hr., C
Access Codes	5	Read/Write	1 Off 2 Room Mode 3 Menus 4 Room Mode and Menus
Relay 2 Configuration	6	Read	1 High Alarm 2 Negative Room Mode 3 Positive Room Mode
Input 1 Configuration	7	Read	1 TSI® Sensor 2 Pressure Transducer
Input 2 Configuration	8	Read	1 TSI® Sensor 2 Pressure Transducer 3 Temperature Setpoint 4 None
Input 3 Configuration	9	Read	1 Supply Pressure Flow 2 Supply Linear Flow 3 Supply Venturi 4 Supply Switch 7 None
Input 4 Configuration	10	Read	1 Room 1 Door Switch 2 Room 1 Occupancy Sensor 3 None
Input 5 Configuration	11	Read	1 Room 1 Key Switch 2 Relative Humidity 3 None

Variable Name	Variable Address	Read/Write	Integer DDC system receives
Input 6 Configuration	12	Read	1 Room 1 Temperature 2 Anteroom Occupancy Sensor 5 Anteroom Door Switch 6 None
Input 7 Configuration	13	Read	1 Room 1 Supply Air Temperature 2 Exhaust Pressure Flow 3 Exhaust Linear Flow 4 Exhaust Venturi 5 Exhaust Switch 7 Anteroom Key Switch 8 None
Room 1 Mode	14	Read/Write	1 Positive 2 Negative 3 No Isolation
Room 1 Low Alarm Enable	15	Read/Write	1 Disabled 2 Enabled
Room 1 High Alarm Enable	16	Read/Write	1 Disabled 2 Enabled
Room 1 Negative Low Alarm Setpoint	17	Read/Write	Displayed in in. W.C. Host DDC system must divide value by 10,000 to report pressure correctly
Room 1 Negative High Alarm Setpoint	18	Read/Write	Displayed in in. W.C. Host DDC system must divide value by 10,000 to report pressure correctly
Room 1 Positive Low Alarm Setpoint	19	Read/Write	Displayed in in. W.C. Host DDC system must divide value by 10,000 to report pressure correctly
Room 1 Positive High Alarm Setpoint	20	Read/Write	Displayed in in. W.C. Host DDC system must divide value by 10,000 to report pressure correctly
Low Exhaust Alarm	21	Read/Write	Displayed in cfm
Low Supply Alarm	22	Read/Write	Displayed in cfm
Room 1 Low Temperature Alarm	23	Read/Write	Displayed in °F Host DDC system must divide value by 10 to report temperature correctly
Room 1 High Temperature Alarm	24	Read/Write	Displayed in °F Host DDC system must divide value by 10 to report temperature correctly
Room 1 Low RH Alarm	25	Read/Write	Displayed in %RH
Room 1 High RH Alarm	26	Read/Write	Displayed in %RH
Room 1 Negative Mode Control Setpoint	27	Read/Write	Displayed in in. W.C. Host DDC system must divide value by 10,000 to report pressure correctly
Room 1 Positive Mode Control Setpoint	28	Read/Write	Displayed in in. W.C. Host DDC system must divide value by 10,000 to report pressure correctly

Modbus Communications (continued)

Variable Name	Variable Address	Read/Write	Integer DDC system receives
Room 1 No Isolation Control Mode	29	Read/Write	1 Position 2 Flow 3 Pressure
Room 1 No Isolation Mode Control Setpoint	30	Read/Write	If No Isolation Control Mode = Position: Displayed in % Open Flow: Displayed in cfm Pressure: Model RPC30 uses Room 1 Negative Mode Control Setpoint or Room 1 Positive Mode Control Setpoint based on prior mode
Room 1 Heating Setpoint, Occupied Mode	31	Read/Write	Displayed in °F Host DDC system must divide value by 10 to report temperature correctly
Room 1 Cooling Setpoint, Occupied Mode	32	Read/Write	Displayed in °F Host DDC system must divide value by 10 to report temperature correctly
Room 1 Heating Setpoint, Unoccupied Mode	33	Read/Write	Displayed in °F Host DDC system must divide value by 10 to report temperature correctly
Room 1 Cooling Setpoint, Unoccupied Mode	34	Read/Write	Displayed in °F Host DDC system must divide value by 10 to report temperature correctly
Room 1 Supply Air Temperature Limit Setpoint	35	Read/Write	Displayed in °F Host DDC system must divide value by 10 to report temperature correctly
Room 1 Minimum Supply Flow Rate Setpoint	36	Read/Write	Displayed in cfm
Room 1 Maximum Supply Flow Rate Setpoint	37	Read/Write	Displayed in cfm
Room 1 Supply Air Heating Flow Rate Setpoint	38	Read/Write	Displayed in cfm
Room 1 Supply Air Cooling Flow Rate Setpoint	39	Read/Write	Displayed in cfm
Room 1 Supply Air Unoccupied Flow Rate Setpoint	40	Read/Write	Displayed in cfm
Supply Air Control Minimum Position	41	Read/Write	0% to 100% Open
Supply Air Control Maximum Position	42	Read/Write	0% to 100% Open
Room 1 Minimum Exhaust Flow Rate Setpoint	43	Read/Write	Displayed in cfm
Room 1 Maximum Exhaust Flow Rate Setpoint	44	Read/Write	Displayed in cfm

Variable Name	Variable Address	Read/Write	Integer DDC system receives
Exhaust Air Control Minimum Position	45	Read/Write	0% to 100% Open
Exhaust Air Control Maximum Position	46	Read/Write	0% to 100% Open
Anteroom Mode	47	Read/Write	1 Positive 2 Negative 3 No Isolation 6 Anteroom not configured
Anteroom Low Alarm Enable	48	Read/Write	1 Disabled 2 Enabled
Anteroom High Alarm Enable	49	Read/Write	1 Disabled 2 Enabled
Anteroom Negative Low Alarm Setpoint	50	Read/Write	Displayed in in. W.C. Host DDC system must divide value by 10,000 to report pressure correctly
Anteroom Negative High Alarm Setpoint	51	Read/Write	Displayed in in. W.C. Host DDC system must divide value by 10,000 to report pressure correctly
Anteroom Positive Low Alarm Setpoint	52	Read/Write	Displayed in in. W.C. Host DDC system must divide value by 10,000 to report pressure correctly
Anteroom Positive High Alarm Setpoint	53	Read/Write	Displayed in in. W.C. Host DDC system must divide value by 10,000 to report pressure correctly
Alarm Reset	61	Read/Write	1 Latched 2 Unlatched
Audible Alarm Enable	62	Read/Write	1 On 2 Off
Alarm Delay	63	Read/Write	Displayed in seconds
Mute Timeout	64	Read/Write	Displayed in minutes
Door Delay	65	Read/Write	Displayed in seconds
Modbus Address	66	Read	
Output 1 Signal Type	67	Read	1 None 2 Exhaust Control
Output 1 Value	70	Read	0 to 100%
Output 2 Signal Type	71	Read	1 None 2 Room 1 Pressure Output 3 Room 1 Supply Control 4 Room 1 Exhaust Flow Output
Output 2 Range	72	Read	If Pressure: Displayed in in. W.C. Host DDC system must divide value by 100 to report pressure correctly If Flow: Displayed in CFM If Control: Displayed in % Open
Output 2 Signal	73	Read	1 4-20 mA 2 0 to 10 VDC
Output 2 Value	74	Read	0 to 100%

Modbus Communications (continued)

Variable Name	Variable Address	Read/Write	Integer DDC system receives
Output 3 Signal Type	75	Read	1 None 2 Room 1 Supply Flow Output 3 Room 1 Exhaust Flow Output 4 Anteroom Pressure Output 5 Room 1 Temperature Control
Output 3 Range	76	Read	If Pressure: Displayed in in. W.C. Host DDC system must divide value by 100 to report pressure correctly If Flow: Displayed in CFM If Control: Displayed in % Open
Output 3 Signal	77	Read	1 4-20 mA 2 0 to 10 VDC
Output 3 Value	78	Read	0 to 100%
Status Index	79	Read	1 Normal 2 Room 1 Negative Low Alarm 3 Room 1 Negative High Alarm 4 Room 1 Positive Low Alarm 5 Room 1 Positive High Alarm 6 Low Exhaust Alarm 7 Low Supply Alarm 8 Low Temperature Alarm 9 High Temperature Alarm 10 Low RH Alarm 11 High RH Alarm 12 Anteroom Negative Low Alarm 13 Anteroom Negative High Alarm 14 Anteroom Positive Low Alarm 15 Anteroom Positive High Alarm 20 Data Error
Room 1 Label	80 to 86	Read	
Anteroom Label	94 to 100	Read	

EXAMPLE of **06 Write Single Register** function format:

This example changes the negative low alarm set point to 0.00060 in. W.C.

QUERY

Field Name	(Hex)
Slave Address	01
Function	06
Starting Address Hi	00
Starting Address Lo	11
Data Value (High)	05
Data Value (Low)	DC
Error Check (CRC)	--

RESPONSE

Field Name	(Hex)
Slave Address	01
Function	06
Starting Address Hi	00
Starting Address Lo	11
Error Check (CRC)	--

EXAMPLE of **03 Read Holding Registers** function format:

This example reads the Room 1 Room Mode and Room 1 Low Alarm Status.

QUERY		RESPONSE	
Field Name	(Hex)	Field Name	(Hex)
Slave Address	01	Slave Address	01
Function	03	Function	03
Starting Address Hi	00	Byte Count	04
Starting Address Lo	0E	Data Hi	00
No. Of Registers Hi	00	Data Lo	02 (2 = Negative)
No. Of Registers Lo	02	Data Hi	00
Error Check (CRC)	--	Data Lo	02 (2 = Alarms Enabled)
		Error Check (CRC)	

LonWorks® Object

Node Object Network Variables

SNVT Number	Bit	Description	SNVT Name	SNVT Type
4			nviRequest	SNVT_obj_request
5			nviTimeSet	SNVT_time_stamp
6			nvoStatus	SNVT_obj_status
7			nvoAlarm	SNVT_alarm
0			nciLocation	SCPTLocation
1			nciOutlnHt	SCTPalrmInbT
2			nciIndex	SCPTdevMajVer
3			nciVersion	SCPTdvMinVer

Room Pressure Controller Object Network Variables

SNVT Number	Bit	Description	SNVT Name	SNVT Type
16		Room 1 Setback Mode	nviSetbackMode	SNVT_occupancy
17		Room 1 Mode	nviRoomMode	SNVT_char_ascii
18		Supply Control Override	nviSupOverride	SNVT_switch
19		Exhaust Control Override	nviExhOverride	SNVT_switch
20		Room 1 Pressure Differential	nvoRm1Press	SNVT_press_f
21		Anteroom Pressure Differential	nvoAntePress	SNVT_press_f
22		Supply Flow	nvoSupplyFlow	SNVT_flow
23		Exhaust Flow	nvoExhaustFlow	SNVT_flow
24		Room Temperature	nvoTempMeas	SNVT_temp_p
25		Relative Humidity	nvoRHMeas	SNVT_lev_percent
26		Status	nvoUnitState	SNVT_state
	1	Room 1 Low Pressure Alarm		
	2	Room 1 High Pressure Alarm		
	3	Anteroom Low Pressure Alarm		
	4	Anteroom High Pressure Alarm		
	5	Low Exhaust Flow Alarm		
	6	Low Supply Flow Alarm		
	7	Low Room Temperature Alarm		
	8	High Room Temperature Alarm		
	9	Low Relative Humidity Alarm		
	10	High Relative Humidity Alarm		
	11	Remote Control Override Status		
27		Room 1 Setback Mode	nvoSetbackMode	SNVT_occupancy
28		Door Mode	nvoDoorMode	SNVT_char_ascii
29		Room 1 Mode	nvoRoomMode	SNVT_char_ascii

SNVT Number	Bit	Description	SNVT Name	SNVT Type
30		Number of Rooms	nvoNumRooms	SNVT_char_ascii
8		Maximum Time Without Sending Update	nciMaxSendTime	SCPTmaxSendTime
9		Minimum Time Before Sending Update	nciMinSendTime	SCPTminSendTime
10		Room 1 Pressure Minimum Update Change	nciSndDeltaP1	SCPTsndDelta
11		Room 2 Pressure Minimum Update Change	nciSndDeltaP2	SCPTsndDelta
12		Exhaust Flow Minimum Update Change	nciSndDeltaF11	SCPTsndDelta
13		Supply Flow Minimum Update Change	nciSndDeltaF12	SCPTsndDelta
14		Room Temperature Minimum Update Change	nciSndDeltaT1	SCPTsndDelta
15		Relative Humidity Minimum Update Change	nciSndDeltaRH	SCPTsndDelta

Description of LON SNVTs

SNVT	Command Supported	Action
nviSetbackMode:	OC_OCCUPIED/ OC_BYPASS OC_UNOCCUPIED/ OC_STANDBY	Sets Room 1 to Normal/Occupied mode Sets Room 1 to Unoccupied mode

NOTICE: All other commands set NORMAL mode

SNVT	Value Sent / Received	Action
nviRoomMode	0	Negative Mode
nvoRoomMode	1	Positive Mode
	2	No Isolation Mode

SNVT	Value Sent	Action
nviSupOverride	x.x 1	Moves damper to override position
nviExhOverride	x.x 0	Exit Override mode
nviTempOverride		x.x is damper position between 0.0 to 100.0

Model RPC30 BACnet® MS/TP Protocol Implementation Conformance Statement

Date: February 1, 2019
Vendor Name: TSI Incorporated
Product Name: PresSura Room Controller
Product Model Number: RPC30
Applications Software Version: 1.0
Firmware Revision: 1.21
BACnet Protocol Revision: Version 1, Rev 8

Product Description:

TSI® Incorporated's PresSura™ controller is designed to maintain the room pressure differential of isolation rooms, operating rooms and other critical environments. This model controller is capable of acting as a stand-alone device or as part of a building automation system via BACnet® MS/TP protocol.

BACnet Standardized Device Profile (Annex L):

- BACnet Operator Workstation (B-OWS)
- BACnet Building Controller (B-BC)
- BACnet Advanced Application Controller (B-AAC)
- BACnet Application Specific Controller (B-ASC)
- BACnet Smart Sensor (B-SS)
- BACnet Smart Actuator (B-SA)

All BACnet Interoperability Building Blocks Supported (Annex K):

Application Service	Designation
Data Sharing – ReadProperty - B	DS-RP-B
Data Sharing – WriteProperty - B	DS-WP-B
Data Sharing – ReadPropertyMultiple - B	DS-RPM-B
Device Management – Dynamic Device Binding - B	DM-DDB-B
Device Management – Dynamic Object Binding - B	DM-DOB-B
Device Management – DeviceCommunicationsControl - B	DM-DCC-B

Segmentation Capability:

- Segmented requests supported Window Size: 480
- Segmented responses supported Window Size: 480

Standard Object Types Supported:

Analog Input Object

- Dynamically Create: Yes No
- Dynamically Delete: Yes No
- Optional Properties: Reliability
- Writable properties: Present_Value when Out_Of_Service is true,
Out_Of_Service
- Proprietary Properties: None
- Property Range Restrictions: None
- Data Type: Real

Analog Value Object

Dynamically Create: Yes No
Dynamically Delete: Yes No
Optional Properties: Reliability
Writable properties: Present_Value, Out_Of_Service
Proprietary Properties: None
Property Range Restrictions: None
Data Type: Real

Binary Input Object

Dynamically Create: Yes No
Dynamically Delete: Yes No
Optional Properties: Reliability, Active_Text, Inactive_Text
Writable properties: Present_Value when Out_Of_Service is true, Out_Of_Service
Proprietary Properties: None
Property Range Restrictions: None
Data Type: Enumerated

Binary Value Object

Dynamically Create: Yes No
Dynamically Delete: Yes No
Optional Properties: Reliability, Active_Text, Inactive_Text
Writable properties: Present_Value, Out_Of_Service
Proprietary Properties: None
Property Range Restrictions: None
Data Type: Enumerated

Device Object

Dynamically Create: Yes No
Dynamically Delete: Yes No
Optional Properties: Max_Master, Max_Info_Frames
Writable properties: Max_Master
Proprietary Properties: None
Property Range Restrictions: None
Data Type: Unsigned Int

Multistate Input Object

Dynamically Create: Yes No
Dynamically Delete: Yes No
Optional Properties: Reliability, State_Text
Writable properties: Present_Value when Out_Of_Service is true, Out_Of_Service
Proprietary Properties: None
Property Range Restrictions: None
Data Type: Unsigned Int

Multistate Value Object

Dynamically Create: Yes No
Dynamically Delete: Yes No
Optional Properties: Reliability, State_Text
Writable properties: Present_Value, Out_Of_Service
Proprietary Properties: None
Property Range Restrictions: None
Data Type: Unsigned Int

Data Link Layer Options:

- BACnet IP, (Annex J)
- BACnet IP, (Annex J), Foreign Device
- ISO 8802-3, Ethernet (Clause 7)
- ANSI/ATA 878.1, 2.5 Mb. ARCNET (Clause 8)
- ANSI/ATA 878.1, RS-485 ARCNET (Clause 8), baud rate(s) _____
- MS/TP master (Clause 9), baud rate(s): 9600, 19200, 38400, 76800
- MS/TP slave (Clause 9), baud rate(s): _____
- Point-To-Point, EIA 232 (Clause 10), baud rate(s): _____
- Point-To-Point, modem, (Clause 10), baud rate(s): _____
- LonTalk, (Clause 11), medium: _____
- Other: _____

Device Address Binding:

Is static device binding supported? Yes No

Networking Options:

- Router, Clause 6 - List all routing configurations, e.g., ARCNET-Ethernet, Ethernet-MS/TP, etc.
- Annex H, BACnet Tunneling Router over IP
- BACnet/IP Broadcast Management Device (BBMD)

Does the BBMD support registrations by Foreign Devices? Yes No

Character Sets Supported:

Indicating support for multiple character sets does not imply that they can all be supported simultaneously.

- ANSI X3.4
- IBM®/Microsoft® DBCS
- ISO 8859-1
- ISO 10646 (UCS-2)
- ISO 10646 (UCS-4)
- JIS C 6226

BACnet® MS/TP Object Set

Object Type	Device Instance	*Units	Description	Writable		Notes and Range
				Object	Value	
Analog Input	1	in. W.C., Pa	Room1 Pressure			
Analog Input	2	cfm, l/s, CMH	Supply Flow Rate			
Analog Input	3		Air Changes Per Hour			
Analog Input	4	% RH	Relative Humidity			
Analog Input	5	°F, °C	Room Temperature			
Analog Input	6	cfm, l/s, CMH	Exhaust Flow Rate			
Analog Input	7	in. W.C., Pa	Anteroom Pressure			1 room with Anteroom configuration only
Analog Input	9	°F, °C	Supply Air Temperature			
Analog Input	10		Room 1 Label	Y		Writing to Object name will change Rm1 Label item. Room 1 Label object has not applicable in. W.C. units. Updating Room 1 Label Object name will not affect other Room 1 Object names.
Analog Input	11		Anteroom Label	Y		Writing to Object name will change AnteRm Label item. Anteroom Label object has not applicable in. W.C. units. Updating Anteroom Label Object name will not affect other Anteroom Object names.
Analog Input	13	% Open	Supply Control Output			Displays 0 if AO2 SIG TYPE is not set to Supply Control 0 to 100
Analog Input	14	% Open	Exhaust Control Output			Displays 0 if AO1 SIG TYPE is not set to Exhaust Control 0 to 100
Analog Input	15	% Open	Reheat Control Output			Displays 0 if AO2 SIG TYPE is not set to Temp Control 0 to 100
Analog Value	1	in. W.C., Pa	Room 1 Neg Low Alarm		Y	-0.19500 to +0.19500 in. W.C.: TSI® Sensor -1.0 in. W.C. to 1.0 in. W.C.: Pressure Transducer
Analog Value	2	in. W.C., Pa	Room 1 Neg High Alarm		Y	0.19500 to +0.19500 in. W.C.: TSI® Sensor -1.0 in. W.C. to 1.0 in. W.C.: Pressure Transducer.

Object Type	Device Instance	*Units	Description	Writable		Notes and Range
				Object	Value	
Analog Value	3	in. W.C., Pa	Room 1 Pos Low Alarm		Y	0.19500 to +0.19500 in. W.C.: TSI® Sensor -1.0 in. W.C. to 1.0 in. W.C.: Pressure Transducer
Analog Value	4	in. W.C., Pa	Room 1 Pos High Alarm		Y	0.19500 to +0.19500 in. W.C.: TSI® Sensor -1.0 in. W.C. to 1.0 in. W.C.: Pressure Transducer
Analog Value	5	cfm, l/s, CMH	Room 1 Low Exhaust Alarm		Y	0 to 30,000 cfm
Analog Value	6	cfm, l/s, CMH	Room 1 Low Supply Alarm		Y	0 to 30,000 cfm
Analog Value	7	°F, °C	Room 1 Low Temperature Alarm		Y	50 to 85°F
Analog Value	8	°F, °C	Room 1 High Temperature Alarm		Y	50 to 85°F
Analog Value	9	% RH	Room 1 Low RH Alarm		Y	0 to 100
Analog Value	10	% RH	Room 1 High RH Alarm		Y	0 to 100
Analog Value	11	ft ³ , m ³	Room 1 Volume		Y	0 to 20,000
Analog Value	12		Room 1 Neg Setpoint		Y	0.19500 to +0.19500 in. W.C.: TSI® Sensor -1.0 in. W.C. to 1.0 in. W.C.: Pressure Transducer.
Analog Value	13		Room 1 Pos Setpoint		Y	0.19500 to +0.19500 in. W.C.: TSI Sensor -1.0 in. W.C. to 1.0 in. W.C.: Pressure Transducer.
Analog Value	14	cfm, l/s, CMH	Room 1 No Isolation Setpoint		Y	Flow: 0 to 30,000 % Open: 0 to 100
Analog Value	15	°F, °C	Occupied Mode Heating Setpoint		Y	55 to 85 °F
Analog Value	16	°F, °C	Occupied Mode Cooling Setpoint		Y	55 to 85 °F
Analog Value	17	°F, °C	Unoccupied Mode Heating Setpoint		Y	55 to 85 °F
Analog Value	18	°F, °C	Unoccupied Mode Cooling Setpoint		Y	55 to 85 °F
Analog Value	19	°F, °C	Heating Mode Supply Temperature Delta		Y	10 to 40°F
Analog Value	20	cfm, l/s, CMH	Occupied Mode Minimum Supply Flow		Y	0 to 10,000 cfm
Analog Value	21	cfm, l/s, CMH	Maximum Supply Flow		Y	0 to 10,000 cfm
Analog Value	22	cfm, l/s, CMH	Occupied Mode Heating Flow		Y	0 to 10,000 cfm

Object Type	Device Instance	*Units	Description	Writable		Notes and Range
				Object	Value	
Analog Value	23	cfm, l/s, CMH	Occupied Mode Cooling Flow		Y	0 to 10,000 cfm
Analog Value	24	cfm, l/s, CMH	Unoccupied Mode Minimum Supply Flow		Y	0 to 10,000 cfm
Analog Value	25	% Open	Minimum Supply Control Output		Y	0 to 100
Analog Value	26	% Open	Maximum Supply Control Output		Y	0 to 100
Analog Value	27	cfm, l/s, CMH	Min Exhaust Flow		Y	0 to 10,000 cfm
Analog Value	28	cfm, l/s, CMH	Max Exhaust Flow		Y	0 to 10,000 cfm
Analog Value	29	% Open	Minimum Exhaust Control Out		Y	0 to 100
Analog Value	30	% Open	Maximum Exhaust Control Output		Y	0 to 100
Analog Value	31	in. W.C., Pa	Anteroom Neg Low Alarm		Y	2 room configuration only -0.19500 to +0.19500 in. W.C.: TSI® S sensor -1.0 in. W.C. to 1.0 in. W.C.: Pressure Transducer
Analog Value	32	in. W.C., Pa	Anteroom Neg High Alarm		Y	2 room configuration only -0.19500 to +0.19500 in. W.C.: TSI® Sensor -1.0 in. W.C. to 1.0 in. W.C.: Pressure Transducer
Analog Value	33	in. W.C., Pa	Anteroom Pos Low Alarm		Y	2 room configuration only -0.19500 to +0.19500 in. W.C.: TSI® Sensor -1.0 in. W.C. to 1.0 in. W.C.: Pressure Transducer
Analog Value	34	in. W.C., Pa	Anteroom Pos High Alarm		Y	2 room configuration only -0.19500 to +0.19500 in. W.C.: TSI Sensor -1.0 in. W.C. to 1.0 in. W.C.: Pressure Transducer
Analog Value	39		Alarm Delay		Y	1 to 600 seconds
Analog Value	40		Mute Timeout		Y	1 to 60 minutes
Analog Value	41		Door Delay		Y	1 to 600 seconds
Analog Value	42		Address		Y	1 to 127
Analog Value	43		MAC ID (Device ID)		Y	0 to 4,194,302
Analog Value	44		Current Heating Control Setpoint		N	55 to 85°F
Analog Value	45		Current Cooling Control Setpoint		N	55 to 85°F
Analog Value	56	% RH	Relative Humidity over BACnet		Y	0 to 100%
Binary Input	1		Room 1 Door Switch			0 Door Closed (Normal) 1 Door Open

Object Type	Device Instance	*Units	Description	Writable		Notes and Range
				Object	Value	
Binary Input	2		Anteroom Door Switch			0 Door Closed (Normal) 1 Door Open
Binary Input	4		Room 1 Occupancy			0 Occupied (Normal) 1 Unoccupied
Binary Input	5		Anteroom Occupancy			0 Occupied (Normal) 1 Unoccupied
Binary Value	1		Room 1 High Alarm		Y	0 Disable 1 Enable
Binary Value	2		Room 1 Low Alarm		Y	0 Disable 1 Enable
Binary Value	3		Anteroom High Alarm		Y	0 Disable 1 Enable
Binary Value	4		Anteroom Low Alarm		Y	0 Disable 1 Enable
Binary Value	10		Relative Humidity over BACnet Enable		Y	0 Disable 1 Enable
Multi-State Value	1		Number of Rooms			1 Single 2 Single + Anteroom
Multi-State Value	2		Devices Controlled			1 None 2 Exhaust 3 Exhaust / Supply / Temp
Multi-State Value	3		Passcode Enable		Y	1 No Password 2 Room Mode Password 3 Menu Password 4 Menu & Room Mode Passwords
Multi-State Value	4		Input 1 Configuration			1 TSI® Sensor 2 Pressure Transducer
Multi-State Value	5		Input 2 Configuration			1 TSI® Sensor 2 Pressure Transducer 3 Temperature Setpoint 4 None
Multi-State Value	6		Input 3 Configuration			1 Supply Pressure Flow 2 Supply Linear Flow 3 Supply Venturi Flow 4 Supply Switch 7 None
Multi-State Value	7		Input 4 Configuration			1 Room 1 Door Switch 2 Room 1 Occupancy Sensor 3 None
Multi-State Value	8		Input 5 Configuration			1 Room 1 Key Switch 2 Relative Humidity 3 None
Multi-State Value	9		Input 6 Configuration			1 Room 1 Temp Sensor 2 Anteroom Occupancy Sensor 5 Anteroom Door Switch 6 None

Object Type	Device Instance	*Units	Description	Writable		Notes and Range
				Object	Value	
Multi-State Value	10		Input 7 Configuration			1 Room 1 Supply Air Temp 2 Exhaust Pressure Flow 3 Exhaust Linear Flow 4 Exhaust Venturi Flow 5 Exhaust Switch 7 Anteroom Key Switch 8 None
Multi-State Value	11		Room 1 Mode		Y	1 Positive 2 Negative 3 No Isolation
Multi-State Value	12		ACH Duct		Y	1 Supply 2 Exhaust 3 Off
Multi-State Value	13		No Isolation Control Type		Y	1 Position 2 Flow 3 Pressure
Multi-State Value	14		Anteroom Mode		Y	1 Positive 2 Negative 3 No Isolation
Multi-State Value	16		Status Index			1 Normal 2 Room 1 Negative Low Alarm 3 Room 1 Negative High Alarm 4 Room 1 Positive Low Alarm 5 Room 1 Positive High Alarm 6 Low Exhaust Alarm 7 Low Supply Alarm 8 Low Temperature Alarm 9 High Temperature Alarm 10 Low RH Alarm 11 High RH Alarm 12 Anteroom Negative Low Alarm 13 Anteroom Negative High Alarm 14 Anteroom Positive Low Alarm 15 Anteroom Positive High Alarm 20 Data Error
Multi-State Value	17		Device Type			1 RPC30
Multi-State Value	18		Units Value		Y	1 in. W.C., cfm, F 2 Pa, ips, C 3 Pa, CMH, C

* The units are based on the value of the Units Value object. When the Units Value is set to 1, the units are in English form. When the Units Value is set to 2 or 3, the units are metric. English is the default value.

Appendix C

Wiring Information

Back Panel Wiring

PIN #	Input / Output / Comm	Signal	Description
1, 2	Input	24 VAC/DC	Power in Digital Interface Module (DIM).
3, 4	Output	24 V	Power for TSI® Pressure Sensors 24 VAC
5, 6	Input	0 to 10 VDC	Input 1
7, 8	Comm	RS-485	Communications between DIM and TSI® Pressure Sensors
9, 10	Output	Open / Closed	Relay 1 Output (Low Alarm)
11, 12	Output	Open / Closed	Relay 2 Output (High Alarm or Room Mode)
13, 14	Input	0 to 10 VDC	Input 2
15, 16	Input	0 to 10 VDC Open / Closed	Input 3
17, 18	Input	Open / Closed	Input 4
19, 20	Input	0 to 10 VDC Resistance	Input 5
21, 22	Input	Resistance Open / Closed	Input 6
23, 24	Input	0 to 10 VDC Resistance	Input 7
25, 26	Output	0 to 10 VDC	Exhaust Control Out
27, 28	Output	0 to 10 VDC 4-20 mA	Analog Out / Supply Control Out
29, 30	Output	0 to 10 VDC 4-20 mA	Analog Out / Temperature Control Out
31, 32, 33	Comm	RS-485	Nurse Station Display 31: B 32: A 33: Ref
34, 35, 36	Comm	Modbus® / BACnet® MS/TP / LON	BAS Communications 34: B 35: A 36: Ref (Modbus / BACnet® MS/TP only)

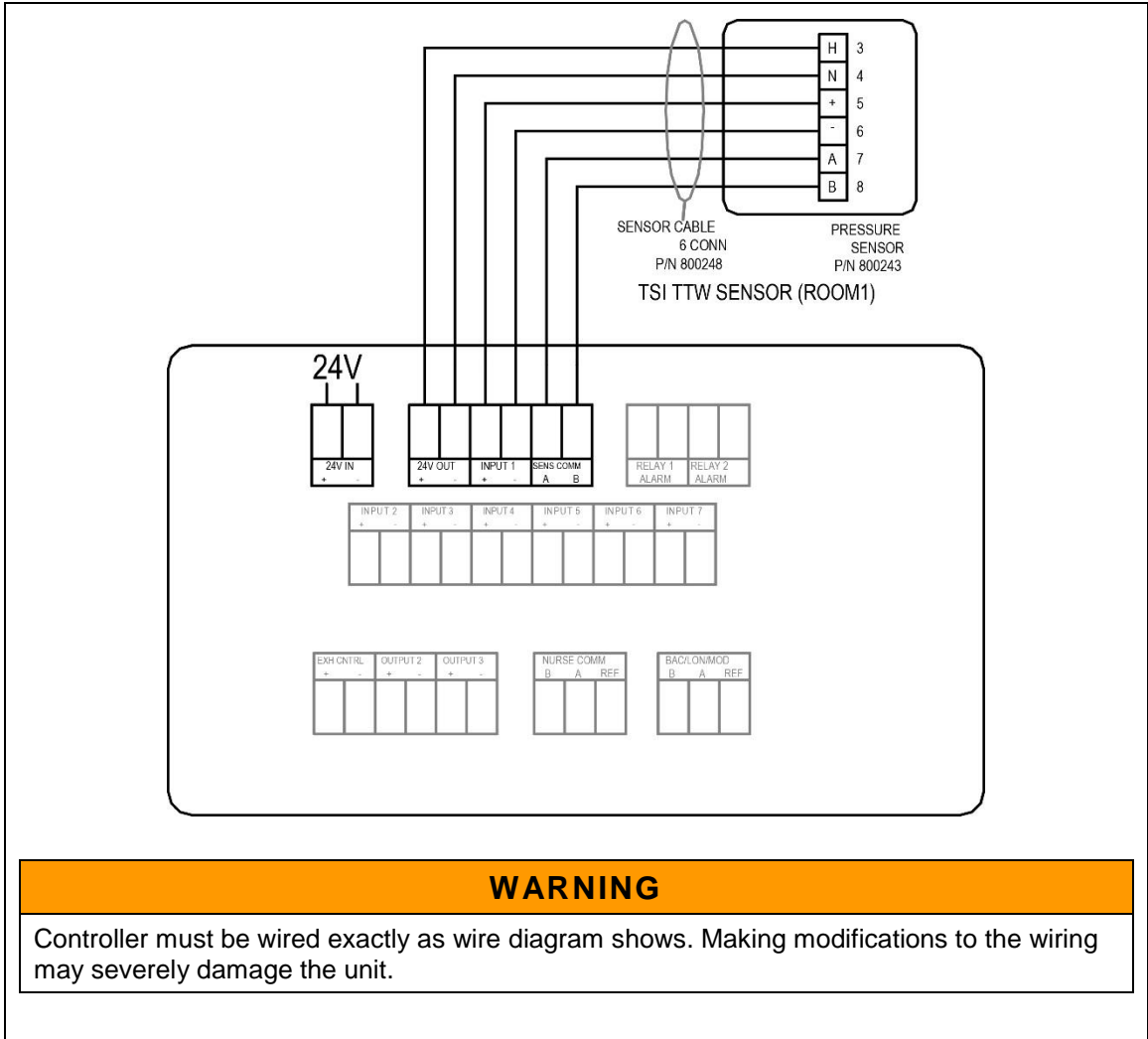
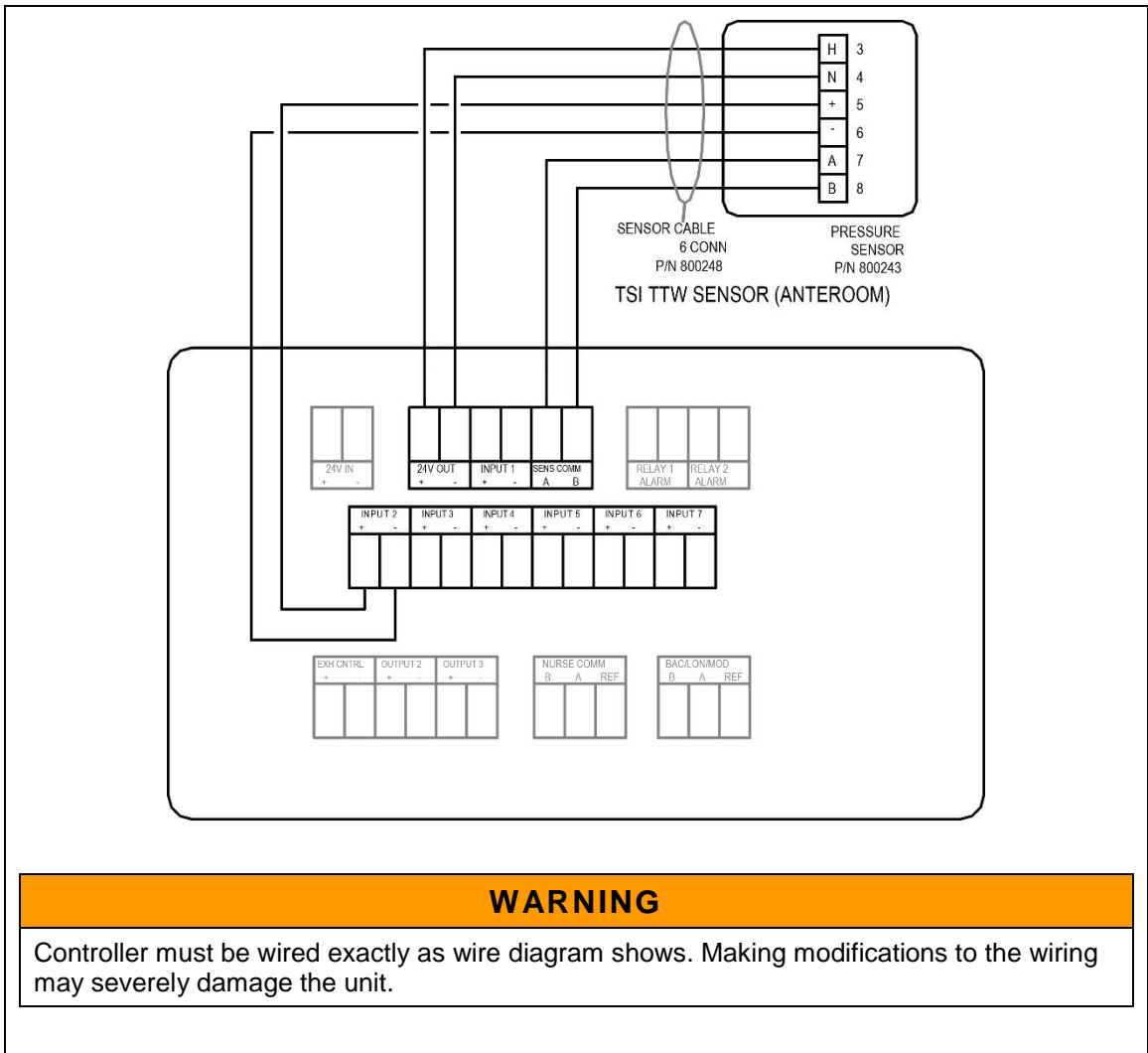

Figure 20: Wiring Diagram –Through-The-Wall Sensor Wiring to Model RPC30



WARNING

Controller must be wired exactly as wire diagram shows. Making modifications to the wiring may severely damage the unit.

Figure 21: Optional Anteroom Through-The-Wall Sensor Wiring to Model RPC30

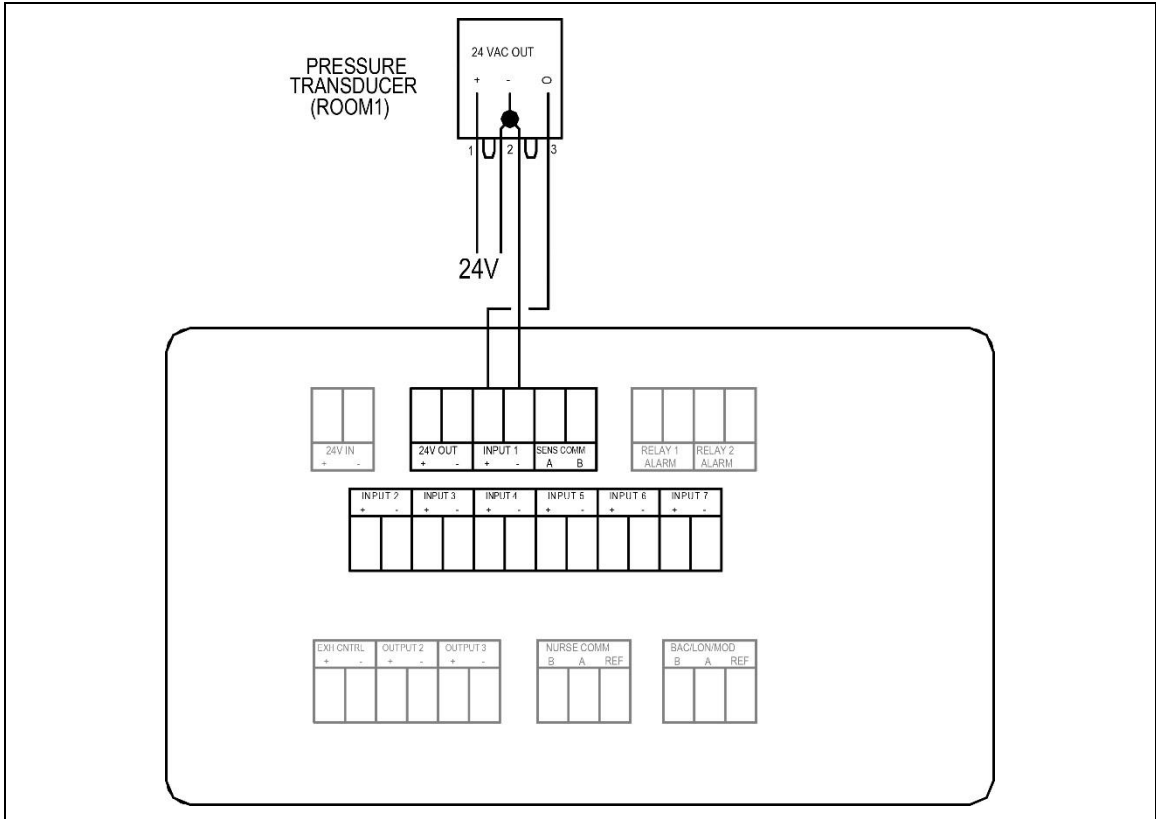

Figure 22. Wiring Diagram – Pressure Transducer Sensor to Model RPC30

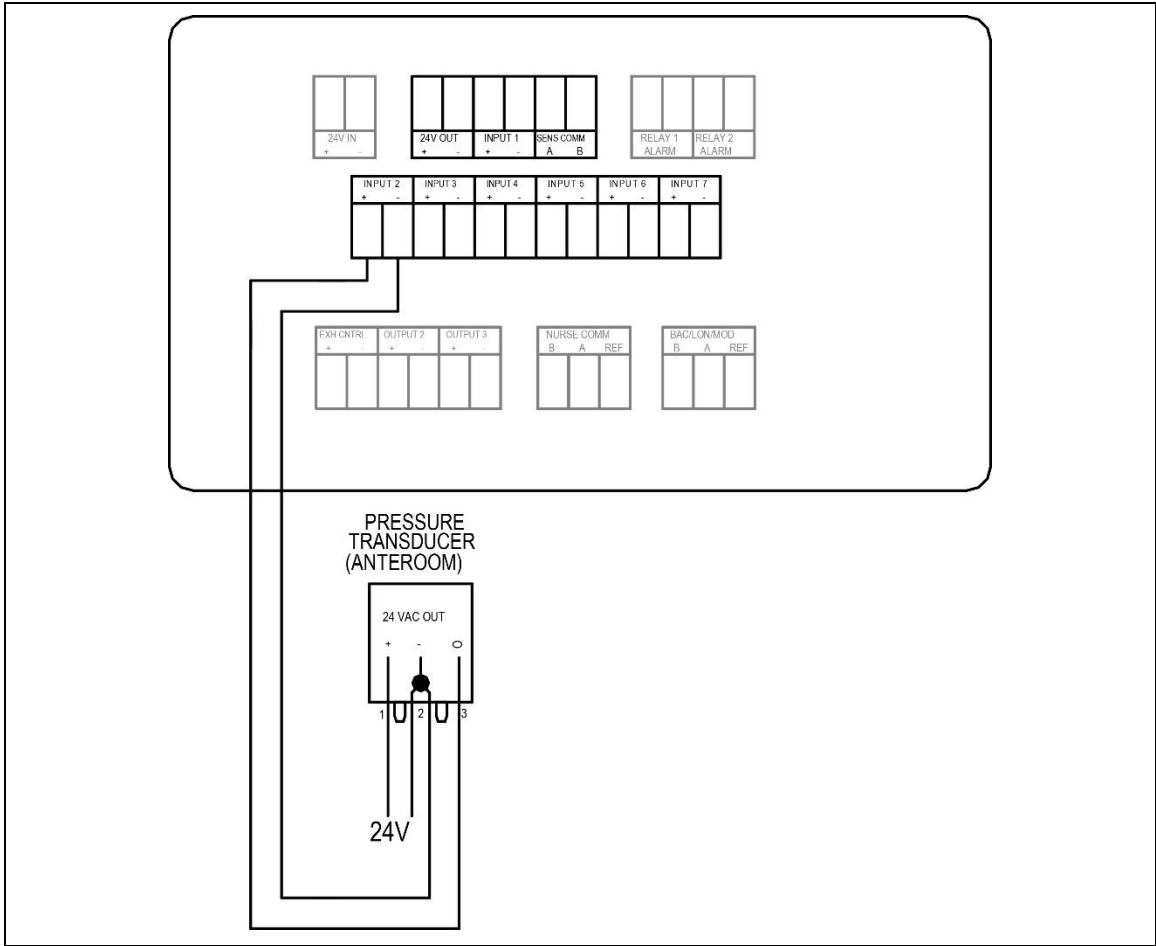

Figure 23. Optional Anteroom Pressure Transducer Sensor Wiring to Model RPC30

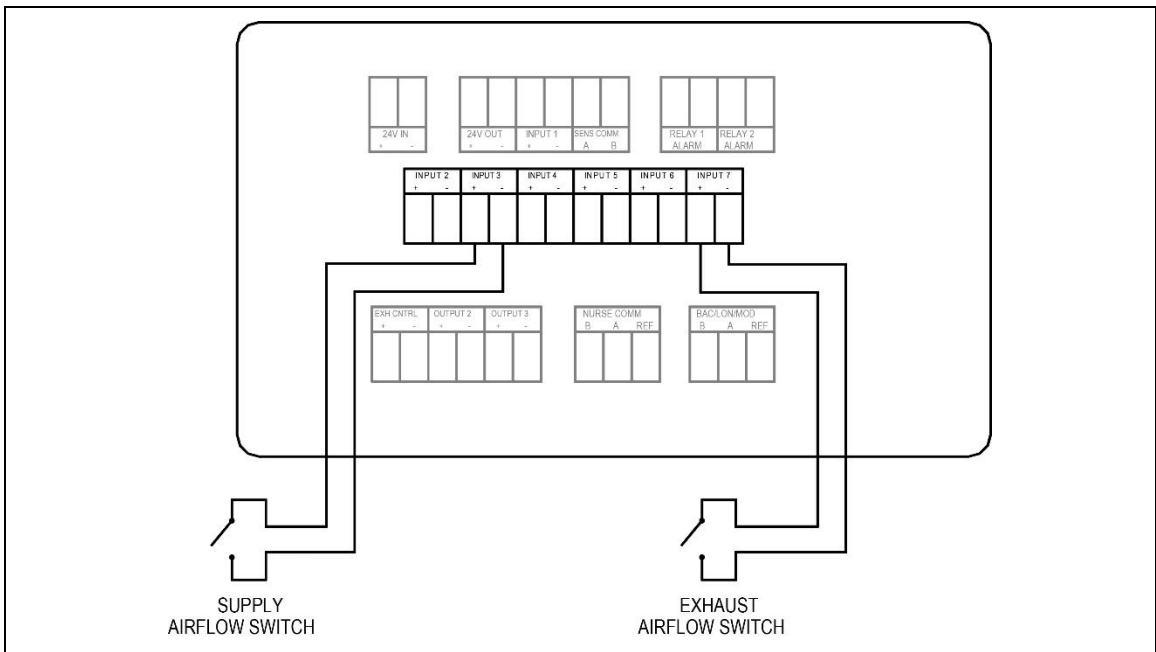

Figure 24. Optional Supply & Exhaust Flow Switch Wiring to Model RPC30

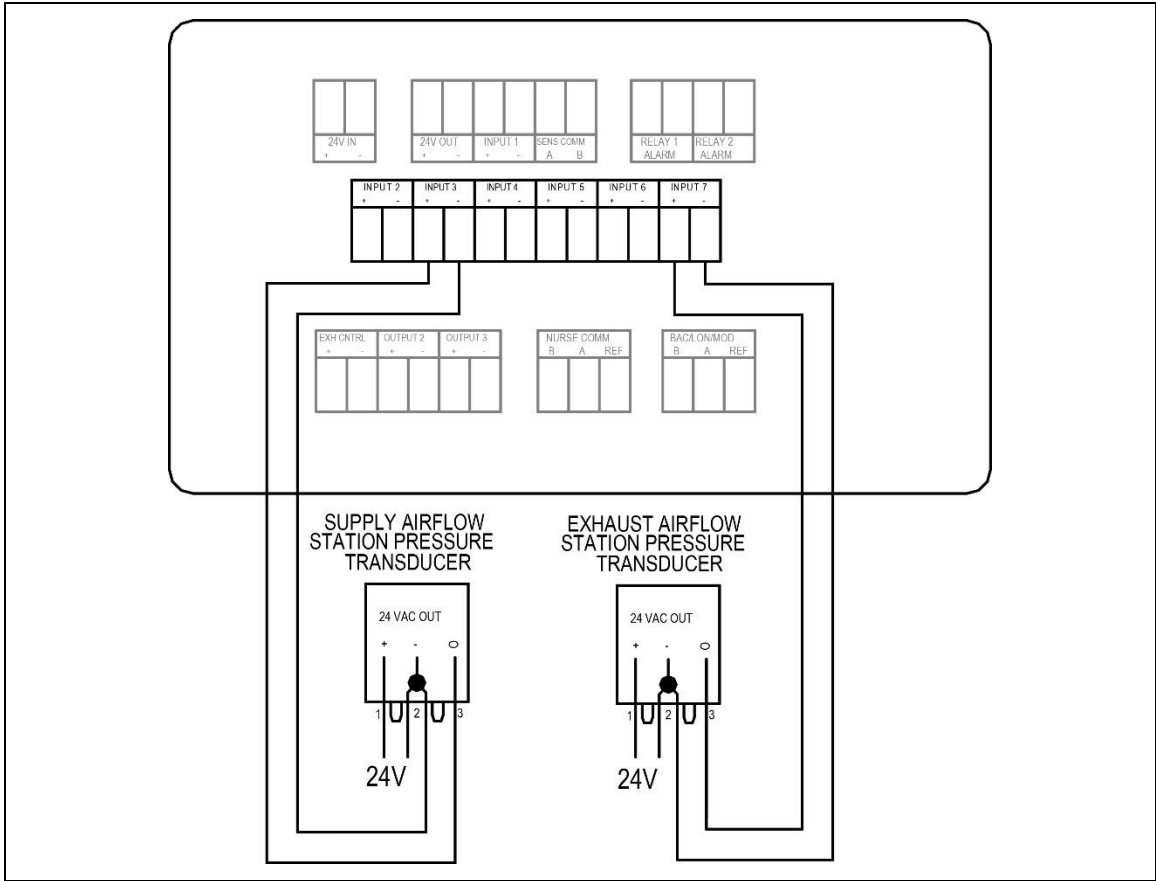

Figure 25. Optional Supply & Exhaust Pressure-Based Flow Station Wiring to Model RPC30

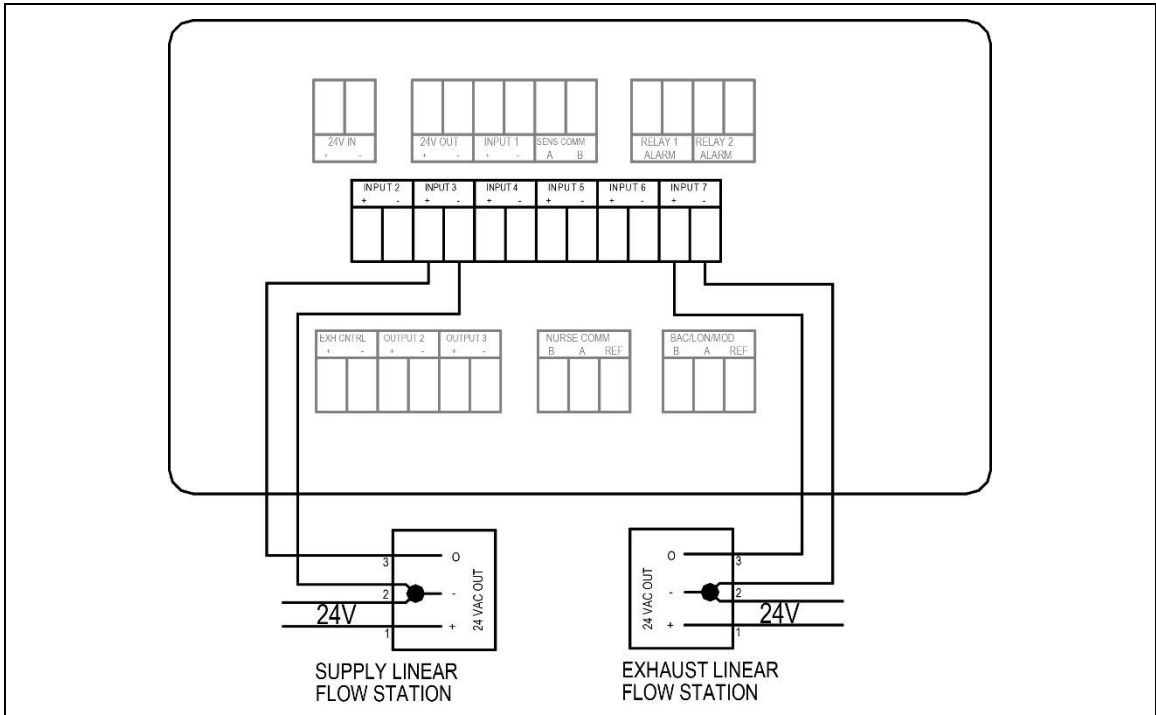

Figure 26. Optional Supply & Exhaust Linear Flow Station Wiring to Model RPC30

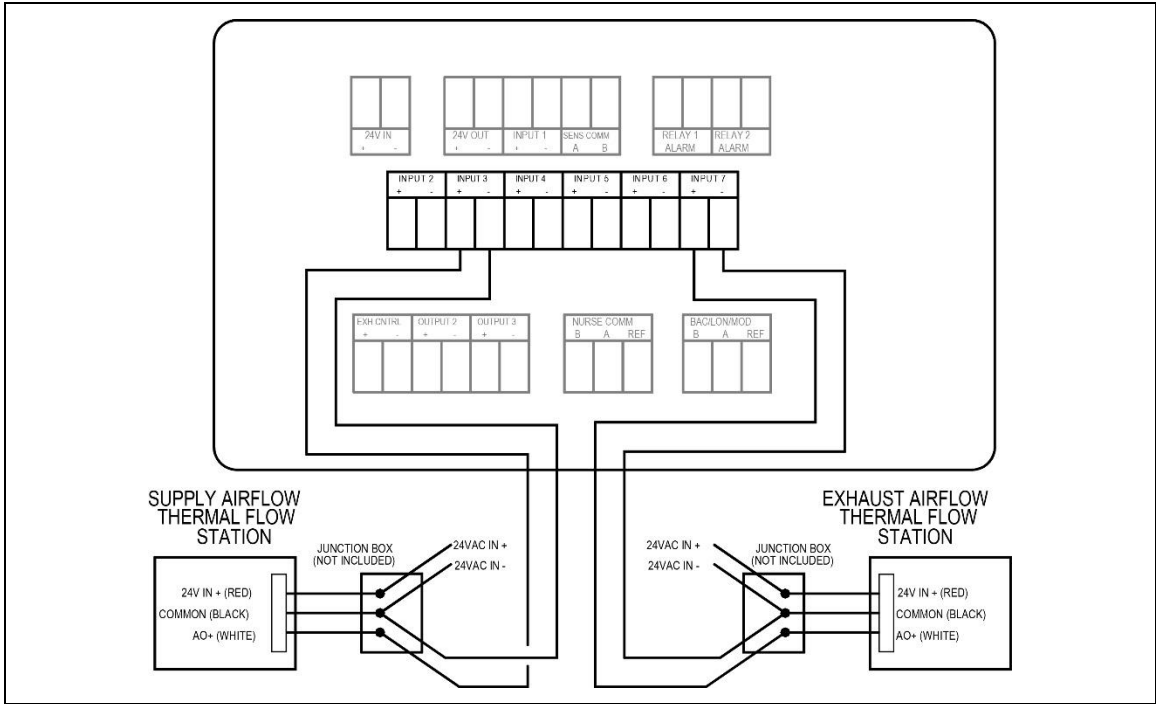

Figure 27. Optional Supply & Exhaust Thermal Flow Station Wiring to Model RPC30

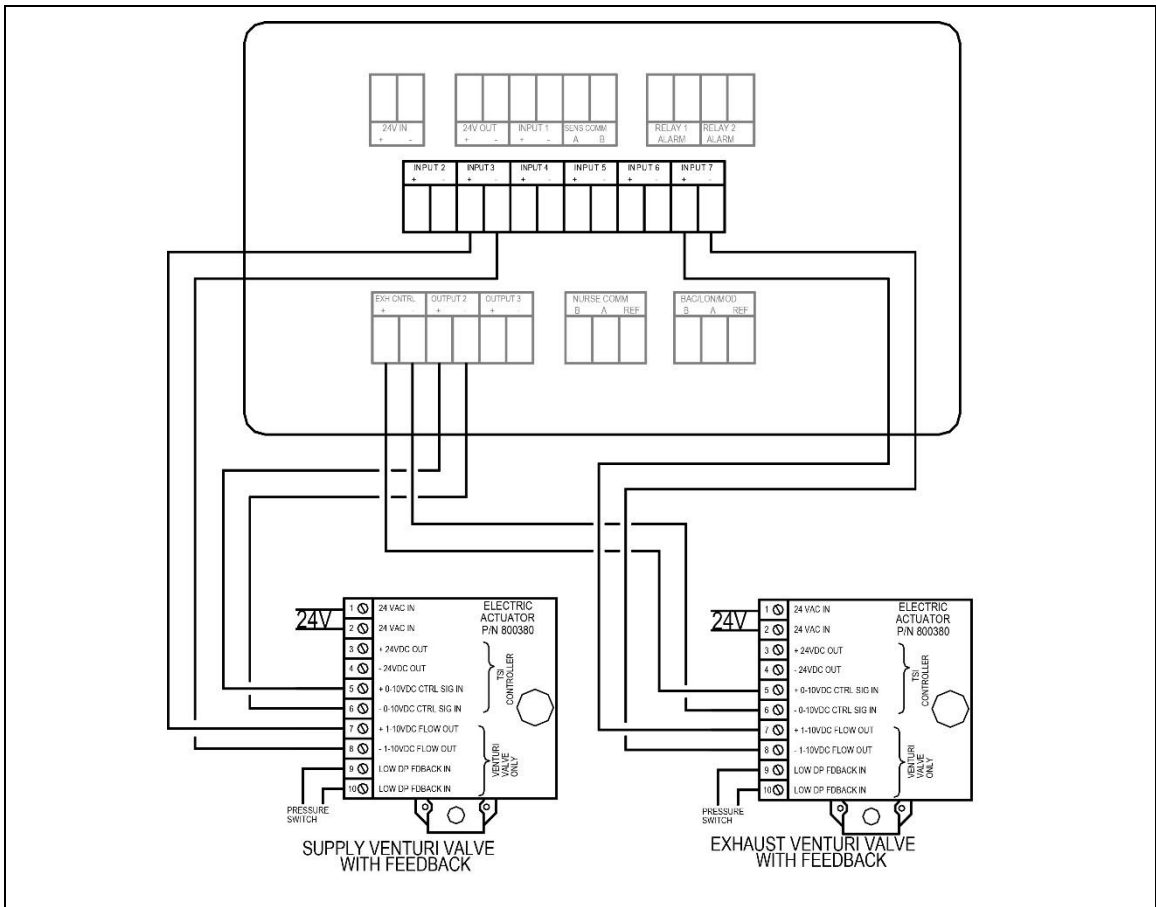

Figure 28. Optional Supply & Exhaust Venturi Valve Wiring to Model RPC30

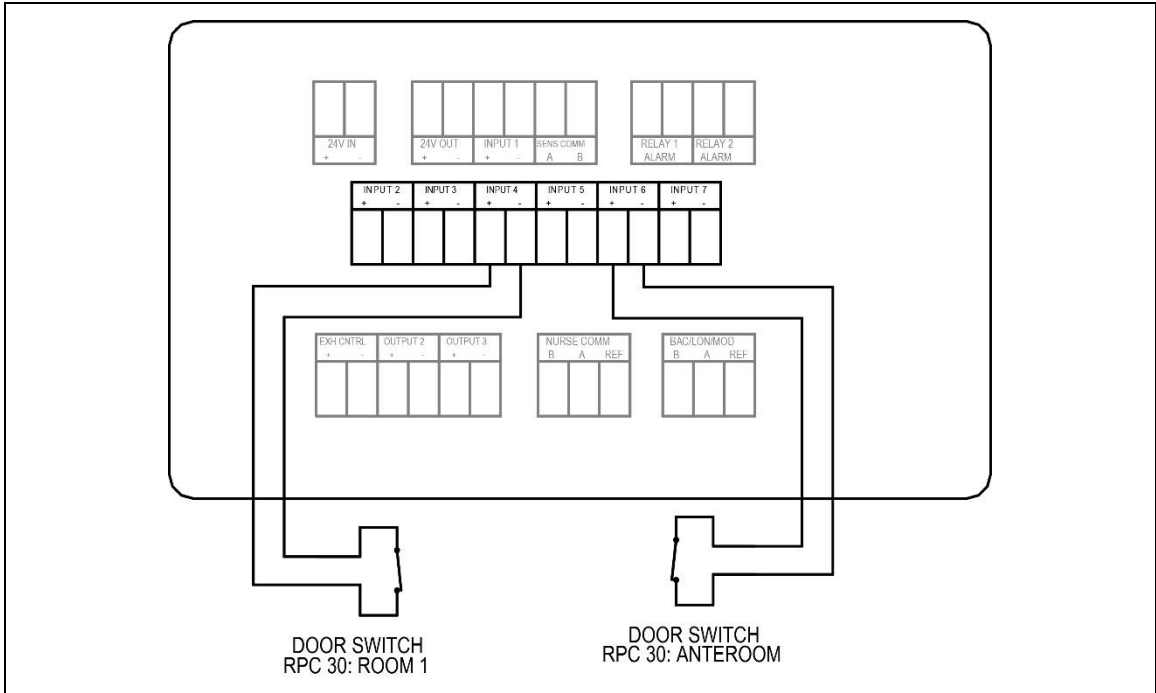

Figure 29. Optional Door Switch Wiring to Model RPC30

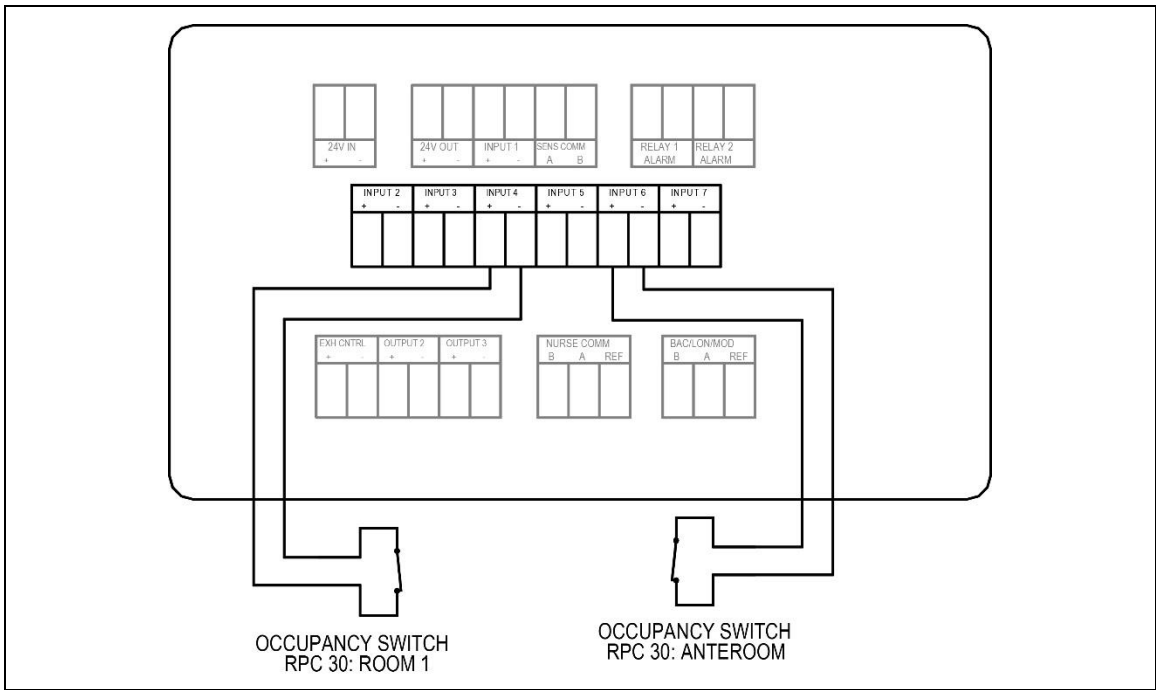

Figure 30. Optional Occupancy Sensor Wiring to Model RPC30

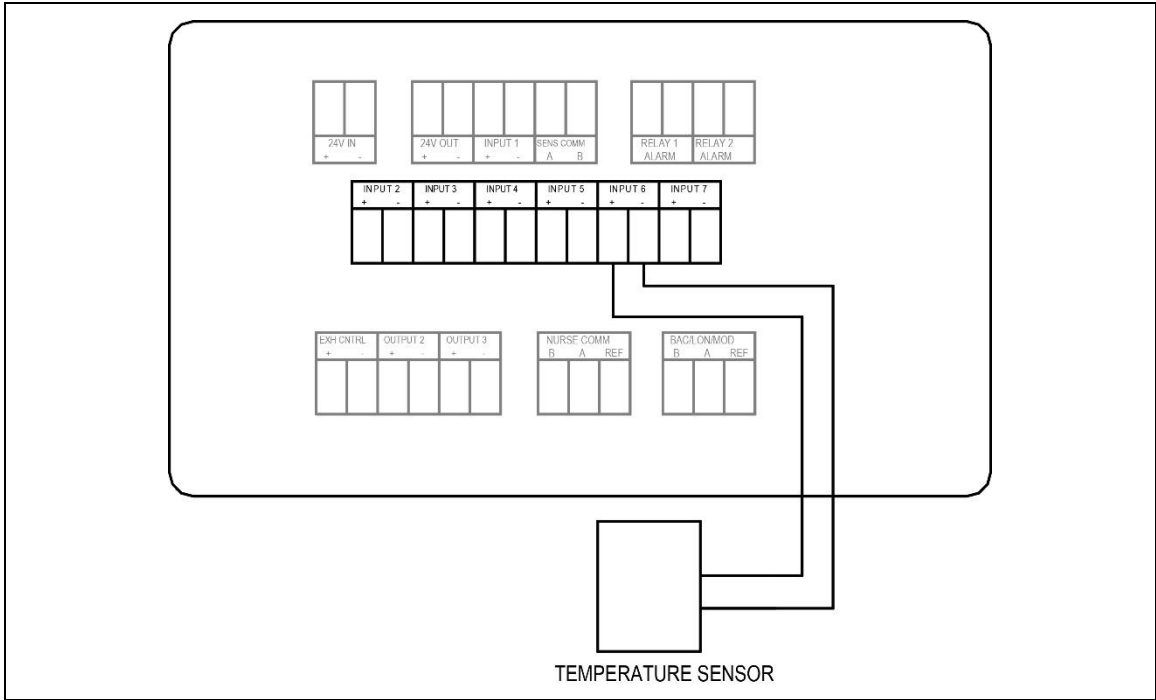

Figure 31. Optional Temperature Sensor Wiring to Model RPC30

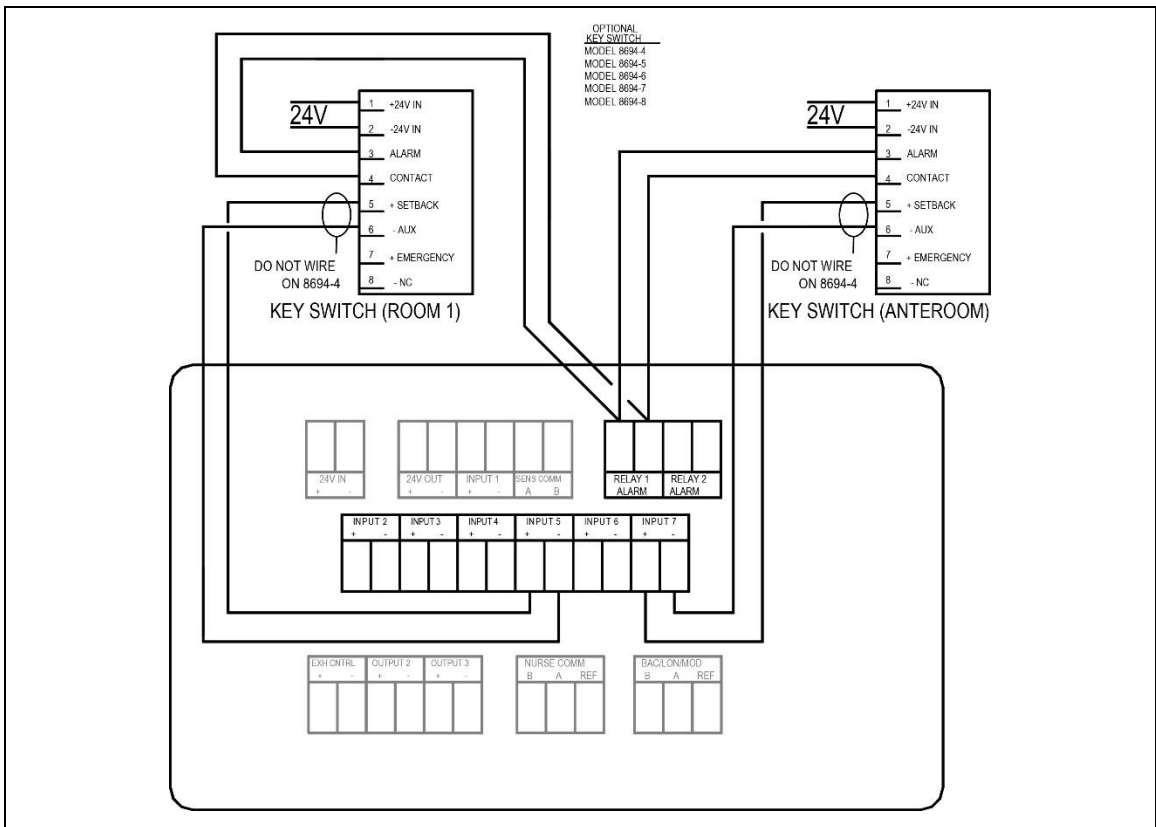

Figure 32. Optional Key Switch Wiring to Model RPC30

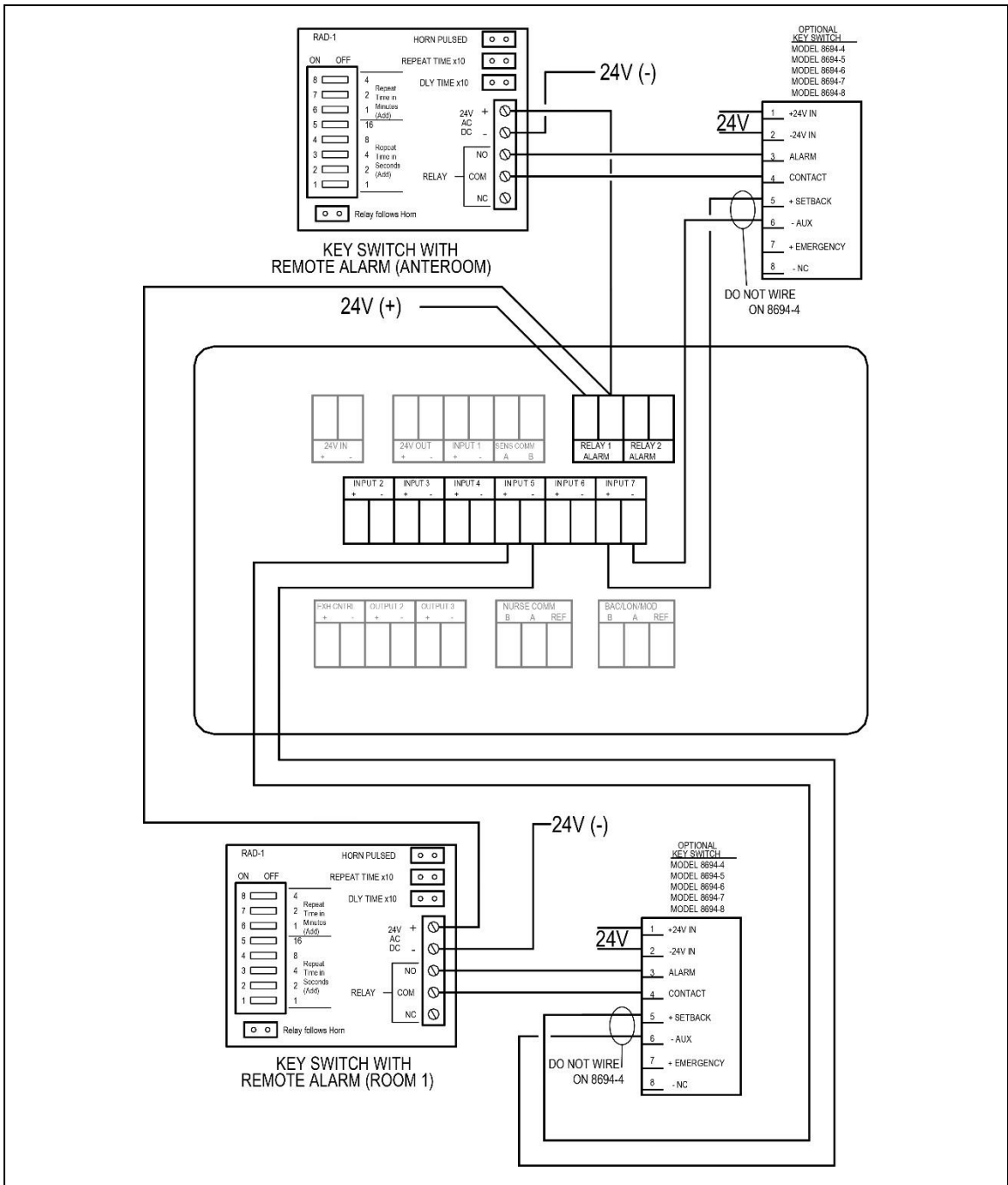

Figure 33. Optional Key Switch with Remote Alarm Wiring to Model RPC30

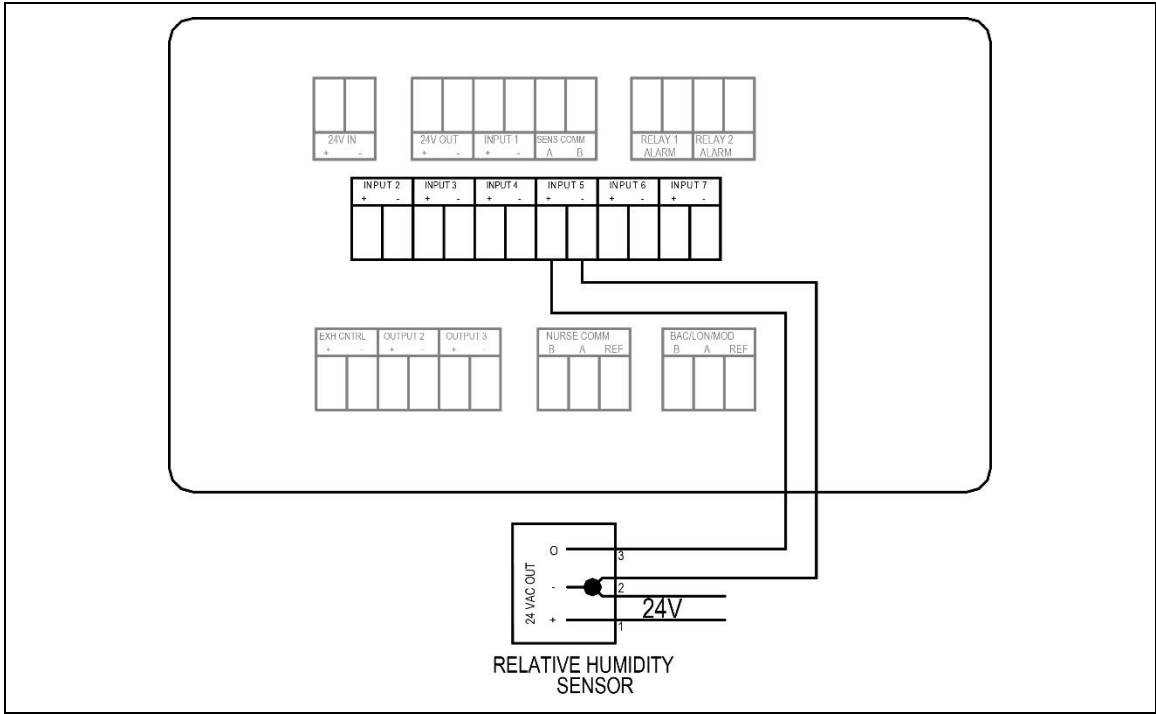

Figure 34. Optional Relative Humidity Sensor Wiring to Model RPC30

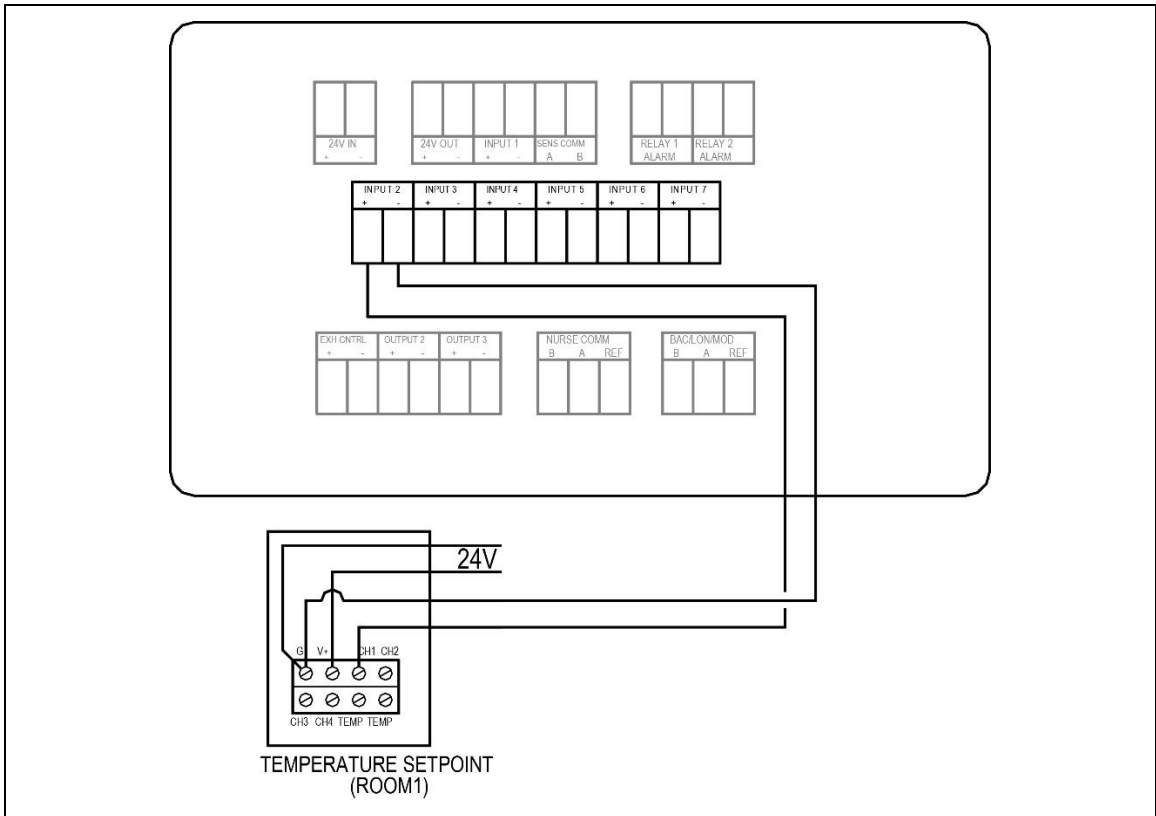

Figure 35. Optional Temperature Setpoint Wiring to Model RPC30

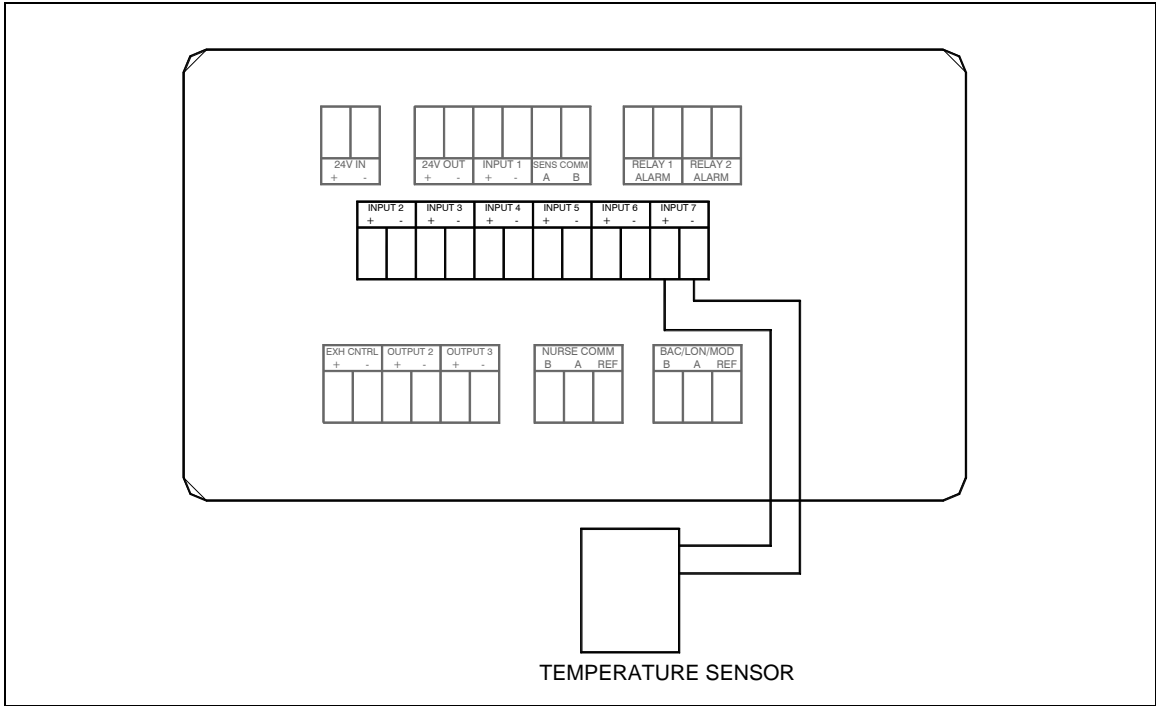

Figure 36. Optional Supply Air Temperature Sensor Wiring to Model RPC30

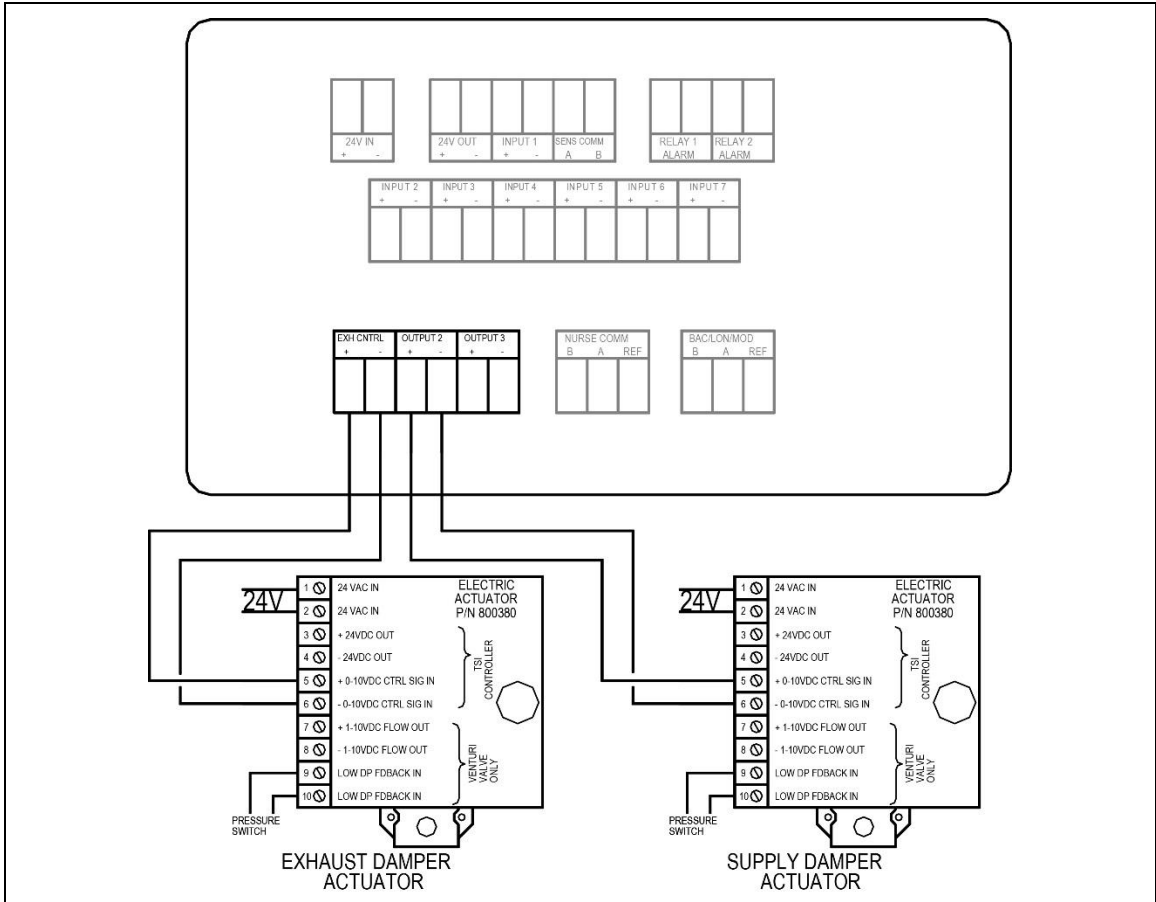

Figure 37. Optional Supply & Exhaust Actuator Wiring to Model RPC30

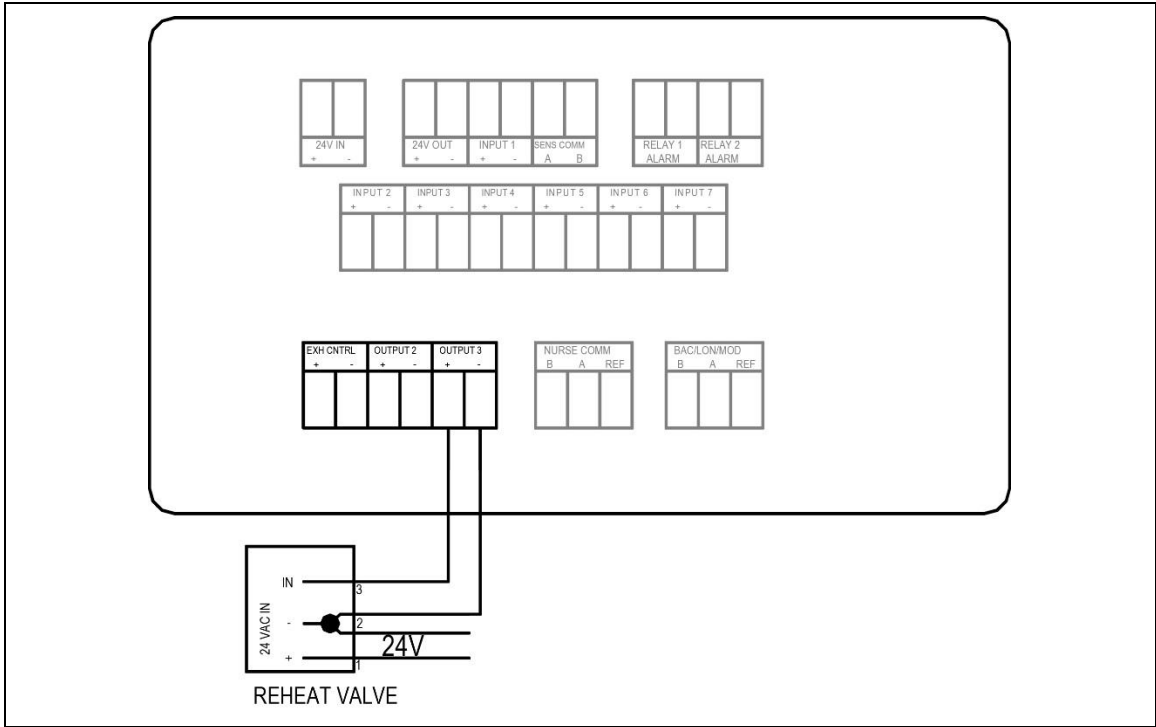
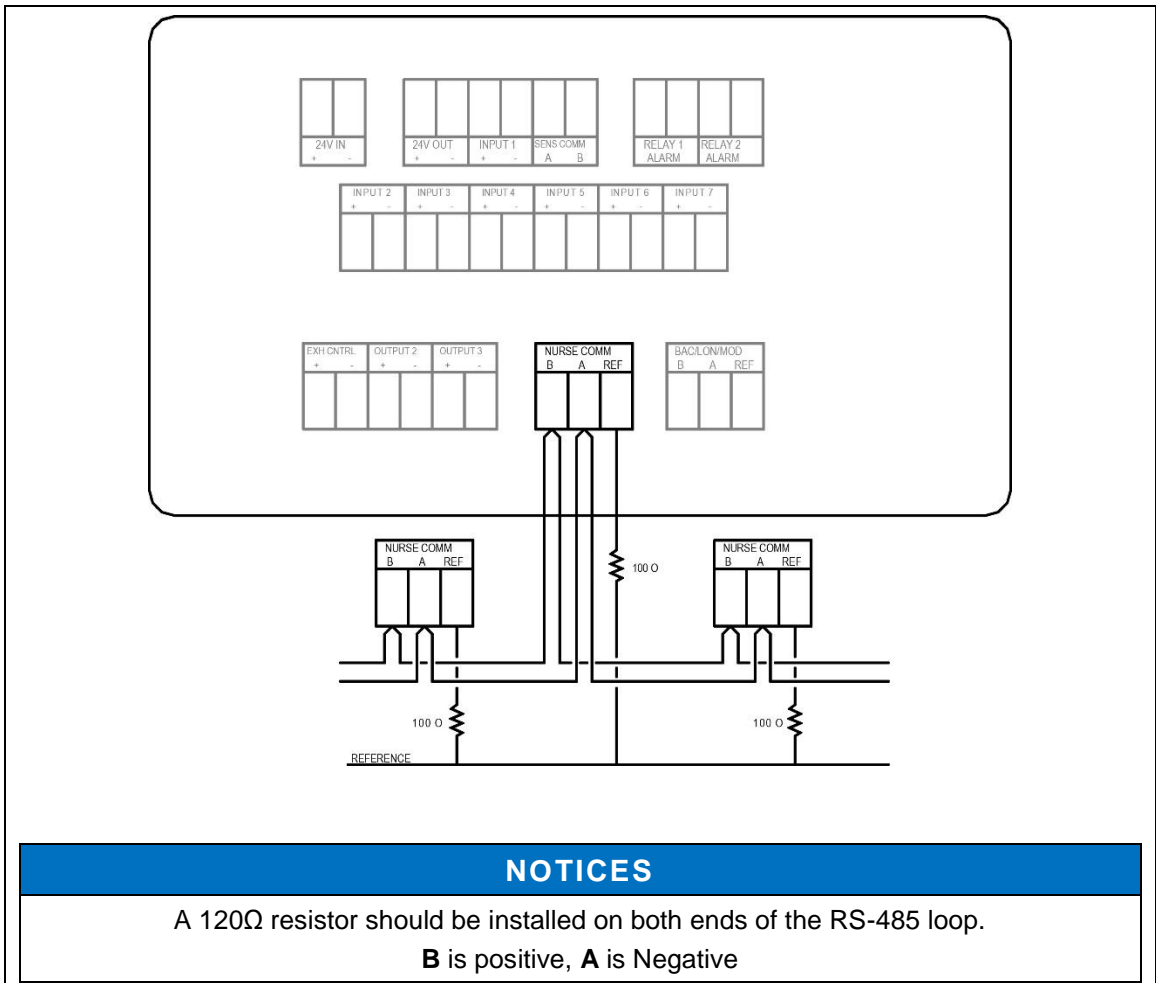

Figure 38. Optional Reheat Actuator Wiring to Model RPC30



NOTICES

A 120Ω resistor should be installed on both ends of the RS-485 loop.

B is positive, **A** is Negative

Figure 39. Wiring Diagram – Optional Nurses Station Communications Wiring to Model RPC30

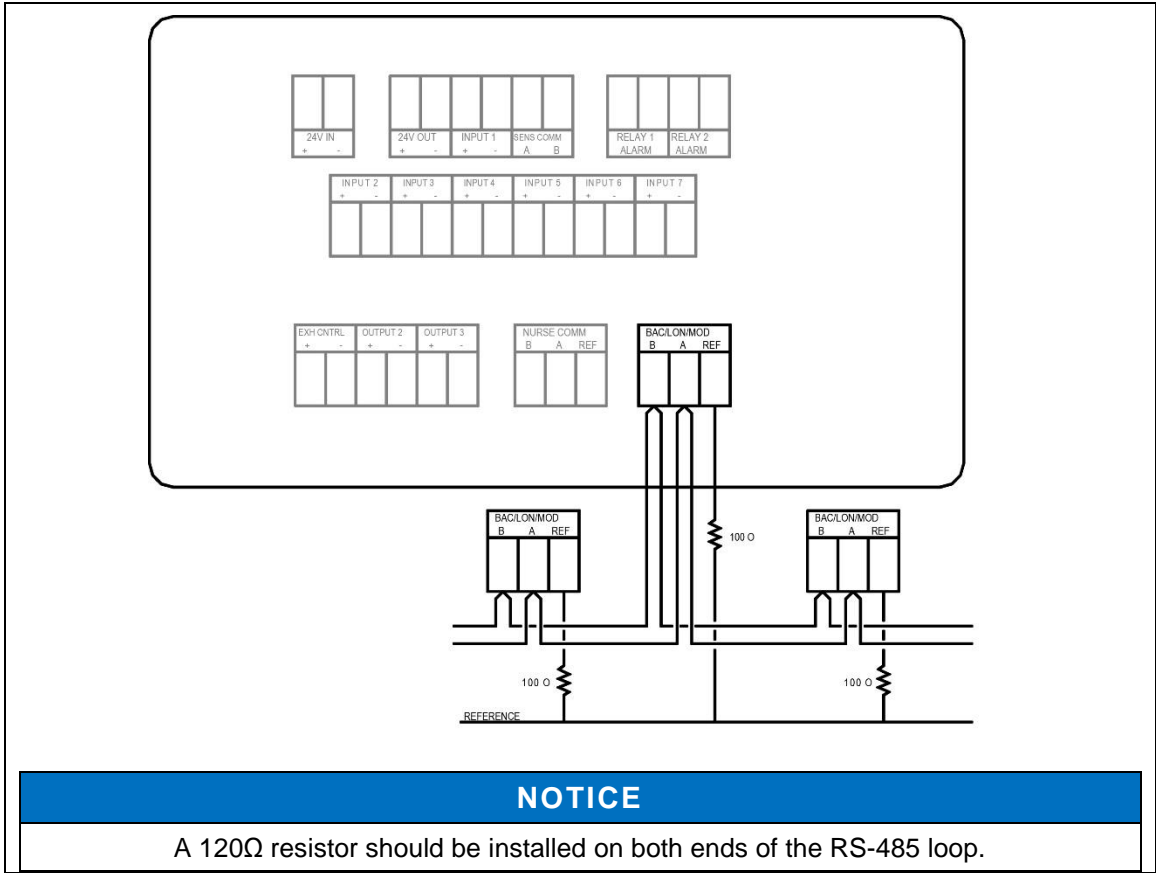

Figure 40. Optional Modbus and BACnet® MS/TP Communications Wiring to Model RPC30

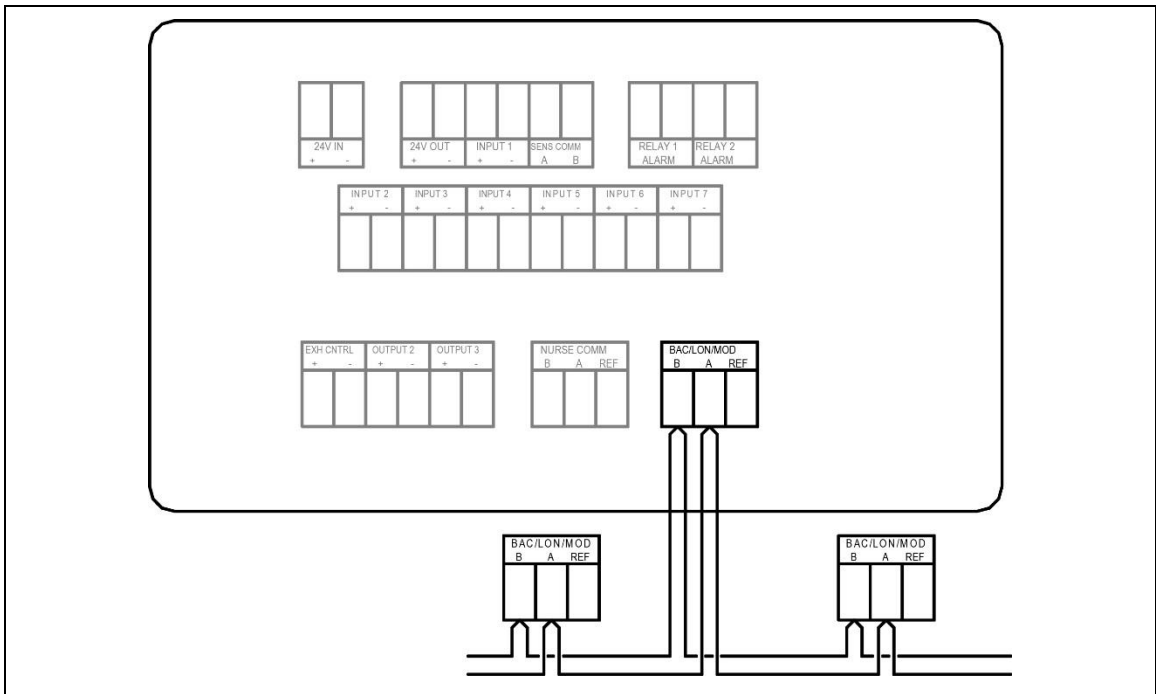

Figure 41. Optional LONworks® Communications Wiring to Model RPC30

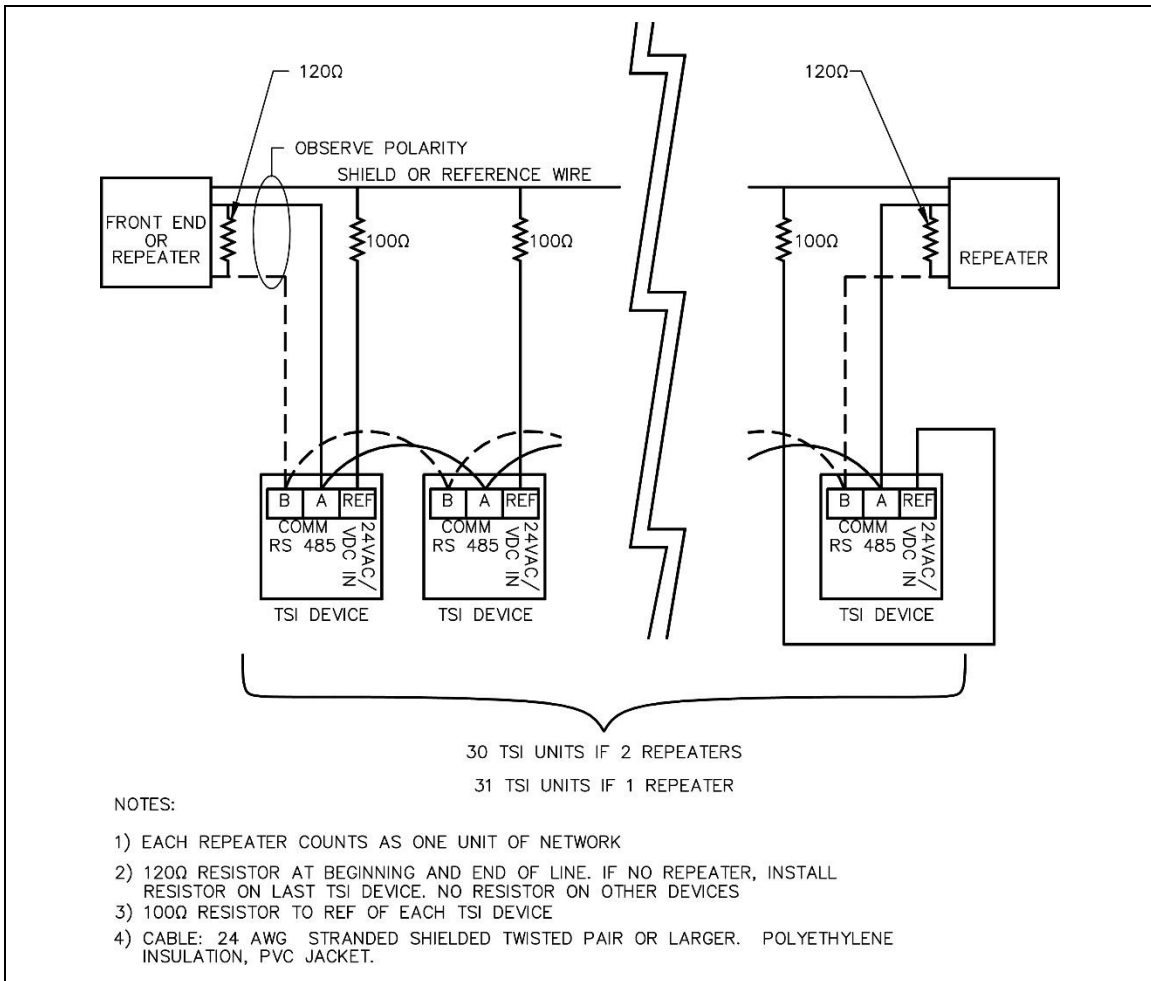

Figure 42. Proper Communication Wiring Diagram

Appendix D

Access Codes / Passcode

The Model RPC30 Room Pressure Controller may prompt you to enter an access code to change the room mode or to enter the menu system. The access code screen is shown below in Figure 43. To enter the access code, type in the 4-digit passcode shown below and press **Save**.

The PresSura™ room controllers feature two levels of passcode access:

- To change the **room mode**, the default passcode is **0317**.
- To access the **menu** system, the default passcode is **2887**.



NOTICE

ROOM MODE and **MENU** passcodes may have been changed. Contact TSI® to recover a lost passcode.



Figure 43. Access Code Screen

(This page intentionally left blank)



Knowledge Beyond Measure.

TSI Incorporated – Visit our website www.tsi.com for more information.

USA	Tel: +1 800 680 1220	India	Tel: +91 80 67877200
UK	Tel: +44 149 4 459200	China	Tel: +86 10 8219 7688
France	Tel: +33 1 41 19 21 99	Singapore	Tel: +65 6595 6388
Germany	Tel: +49 241 523030		

P/N 6006643 Rev. L ©2023 TSI Incorporated Printed in U.S.A.

